

# ENTTEC

PROFESSIONAL LED LIGHTING + CONTROL SOLUTIONS

2026 catalogue



# Welcome to ENTTEC



## Our offices

### ENTTEC ASIA-PACIFIC

43 Indian Drive  
Keysborough, VIC 3173  
Australia  
+61 3 9763 5755  
sales@enttec.com.au  
enttec.com.au/support

### ENTTEC EUROPE

Floor 3, News Building  
3 London Bridge Street  
London SE1 9SG, UK  
+44 (0) 208 079 9640  
sales@enttec.co.uk  
enttec.co.uk/support

### ENTTEC CHINA

Room A3, No. 107  
Baisha Shui Road, Changban  
Tianhe District, Guangzhou, China  
+86 139 2907 0269  
sales@enttec.com.cn  
enttec.com.cn/support

### ENTTEC AMERICAS

600 Park Offices Drive, LL-58  
Durham, NC 27709, USA  
(888) 454-5922  
sales.americas@enttec.com  
enttec.com/support

### ENTTEC MIDDLE EAST

Al Quoz Industrial Area # 04 /  
S03, 26th Street  
Plot number 369-0478 /  
Warehouse # 03 / PO BOX 643989  
Dubai, UAE  
+971 (4) 337 4500  
sales@enttec.ae  
enttec.ae/support

*Cover image: a night view of the Yeongdong-gun Rainbow Tower, a new landmark in South Korea's wine region, brought to life with dynamic lighting controlled by an ENTTEC S-PLAY SP1-1.*

# What's hot?

Control LED pixel lighting over Ethernet the easy way.

PAGE 43



SMART LED pixel dots for professional installations: now also available in white.

PAGE 16



State-of-the-art lighting hardware interface for musicians.

PAGE 62







PAGE 35



Next-Gen compact and powerful 32U LED pixel controller with variable output configuration.

## Join us

-  [facebook.com/enttec](https://facebook.com/enttec)
-  [youtube.com/enttecofficial](https://youtube.com/enttecofficial)
-  [instagram.com/enttecofficial](https://instagram.com/enttecofficial)
-  [linkedin.com/company/enttec](https://linkedin.com/company/enttec)

## Contents

An introduction to ENTTEC	4
The ENTTEC pixel system	6
Show control	10
Pixel lights	16
Pixel software	28
Pixel control	34
Constant current / constant voltage control	47
Constant voltage lights	49
Network	50
DMX management	52
Lighting control for musicians	60



**AMERICAS**  
RALEIGH-DURHAM, USA



A3

恩特可科技(广州)  
**ENTTEC**



**CHINA**  
GUANGZHOU

# Our story.



**MIDDLE EAST**  
DUBAI, UAE



**GLOBAL HQ (ASIA-PACIFIC)**  
MELBOURNE, AUSTRALIA

Australians are well-known for their no-nonsense, pioneering spirit. And having confronted the question, “*Why can’t I control DMX lights from a computer?*” this is precisely what Nicolas Moreau channelled in 1999 when he conceived and developed a world first PC-to-light fixture interface: the **Open DMX USB**.

Designed to be high-quality, affordable, and compatible with existing systems, it was a well-engineered yet deceptively simple device. What’s more, as the ‘Open’ part of the name suggests, its schematics were made freely available for

anybody to study and replicate, thus ensuring that this new technology would rapidly spread and herald previously unheard-of creative possibilities that would revolutionise the lighting industry.

The ENTTEC brand grew from both this product and its transparent philosophy, rapidly developing a reputation, not just for engineering expertise, fine craftsmanship and technical innovation (with several products becoming global industry standards), but also for the kind of fast and flexible support and service that lighting professionals demand. We set out to treat our clientele as we’d like to be treated ourselves - with integrity, proficiency and dedication to achieving the best possible outcome.

## ENTTEC

Entertainment Technology

1999

Invention of the OPEN DMX USB leads to the founding of ENTTEC.

2010-2013

ENTTEC expands internationally, establishing offices in North Carolina (USA) and London (UK).

2020

SMART PXL dot LED fixtures are manufactured by ENTTEC at our Australian facility to ensure premium quality as well as reducing our carbon footprint.

2023

One of the fastest growing cities in the world, Dubai is chosen to bring ENTTEC’s lighting expertise to the Middle East for the first time.

2003

DMX over Ethernet is introduced, enabling longer and faster lighting installations.

2017

ENTTEC LED Mapper (ELM) wins Live Design Lighting Control Software of the Year award.

2022

Factory expansion and smart thinking during the global pandemic results in the ability for all ENTTEC products to be manufactured entirely in-house.

2024

To bring products closer to our Asian customers, ENTTEC opens a fifth international office in China’s foremost commercial hub, Guangzhou.

ENTTEC

Dating back to the year 2000, one of ENTTEC's oldest products, the original **DMXPlayBack**, sits behind its modern day evolution: the intelligently designed **S-Play SP1-1**.



As the scope and popularity of our product range increased, so did the need to expand our operations internationally. To accompany our state-of-the-art design and manufacturing facility in Australia, we established ENTTEC Americas in 2010, based in the famous Research Triangle region of North Carolina, USA, as well as ENTTEC Europe in 2013, with an office in London and dealers throughout the continent. We are also proud to have opened our first Middle Eastern office in Dubai in 2023, followed by Guangzhou in China in 2024.

Now a major player in the global lighting industry - known for our high-end LED luminaires, pixel system innovations, and true end-to-end solutions for virtually any project - we like to keep our focus firmly on the future through continual research and testing.

Our momentum derives from a genuine hunger to push beyond the boundaries of what's currently possible, and the desire to pass our discoveries on to you.

It is our goal to ensure that our products continue to inspire users throughout the world to produce amazing visuals showcasing the zenith of creative technology.

Of course, we also ensure that our products are compliant with key international regulatory standards, including:



\* select products only

Our products have played a role in projects for a range of international clientele, including:



*“A well-designed and built lighting system does more than provide illumination. It provides inspiration.”*

Nicolas Moreau  
ENTTEC founder

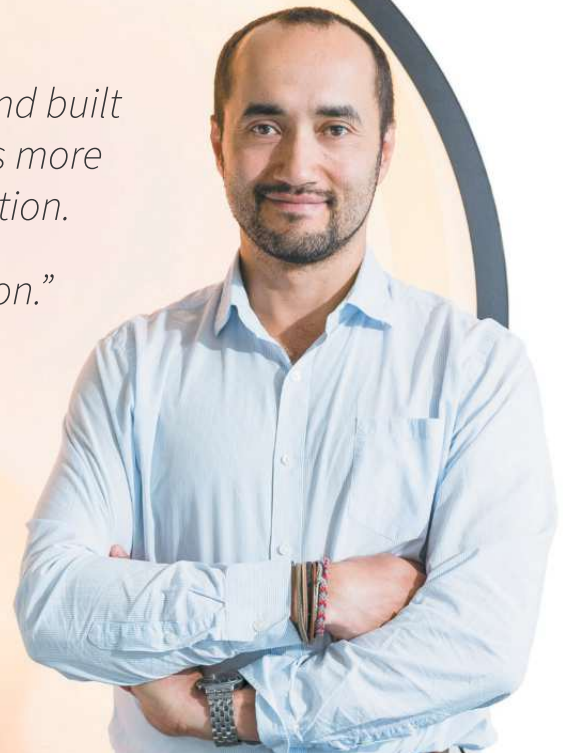

# We are the pixel experts.

If you're looking for an end-to-end solution to produce a spectacular lighting display that's not only highly customisable, but simple to configure and control, look no further than ENTTEC's famous pixel system.

Thanks to years of meticulous research and development, our pixel technology is designed to give you the power to harness an incredible selection of compatible devices in a multitude of ways, bringing an almost infinite array of creative possibilities on any scale.

## Why pixels?

With traditional setups, every LED in a series has to do the same as the others. But with pixel technology, each LED can be controlled independently - opening the door to almost countless possibilities.

## The ENTTEC pixel system

### Mapping PAGE 26

To map physical LEDs to video content, you'll need LED mapping software. ENTTEC LED Mapper (ELM) was voted 'Best Lighting Control Software of the Year' by a panel of industry experts at the Live Design Awards 2017.

ELM enables you to map vector curves and other tricky shapes, then use its internal effects library or even your own videos or audio to control your LEDs.



The award-winning **ENTTEC LED MAPPER (ELM)** software now comes bundled with selected **PIXEL PRODUCTS**, featuring a **FREE** license that enables you to map and control the equivalent amount of LED pixels that your chosen product is capable of.

Look out for this icon!



### The ultimate smart show controller PAGE 10

The S-PLAY is your all-in-one solution for the recording, triggering, and activation of not only light shows but video, non-lighting events, and much more. Create a show with ELM, then store it on S-PLAY to activate precisely when you need it.



### For grand scale projects and long distances PAGE 43

The **PIXELATOR MINI MK2** is a compact Ethernet converter that outputs ENTTEC's PLink protocol - designed for outstanding performance and perfect synchronisation across its 16 multi-Universe ports.

### For dense pixel arrays

PAGE 35

The OCTO Mk3 is a 32-universe pixel controller with network linking and flexible port configuration, powered by a wide 5-60V DC input range. Delivering double the capacity of the OCTO Mk2, expanded output options, and broad protocol support with data and clock, the OCTO Mk3 offers exceptional flexibility in a compact form.

### Add LED pixel strips

PAGE 22

For tighter spaces and stealth installations, our range of classic 5V and 12V **PIXEL STRIPS** are the way to go. Manufactured to the highest standards, with better substrates and thicker copper than other strips on the market, ENTTEC pixel strips are quality checked and tested by our team of engineers in order to ensure optimal compatibility with our range of controllers.

### Add LED pixel dots

PAGE 16

ENTTEC's **SMART PXL dot** series are the professional choice for LED installations.

These flexible lengths of customizable, high-intensity, full-spectrum LED nodes have been designed from the ground upward for a robust installation. Suited for indoor or outdoor usage, they come in default strings of 20 and feature different diffuser options.

### Inject data + power

PAGE 46

Extend your layout up to 300 metres over standard CAT6 cable by using ENTTEC's PLink protocol. Developed especially for pixel projects, simply BYO power supply and inject via a **PLINK INJECTOR** (standard and robust IP66 versions available).

Learn more about our **PIXEL PRODUCTS** where you see this icon.

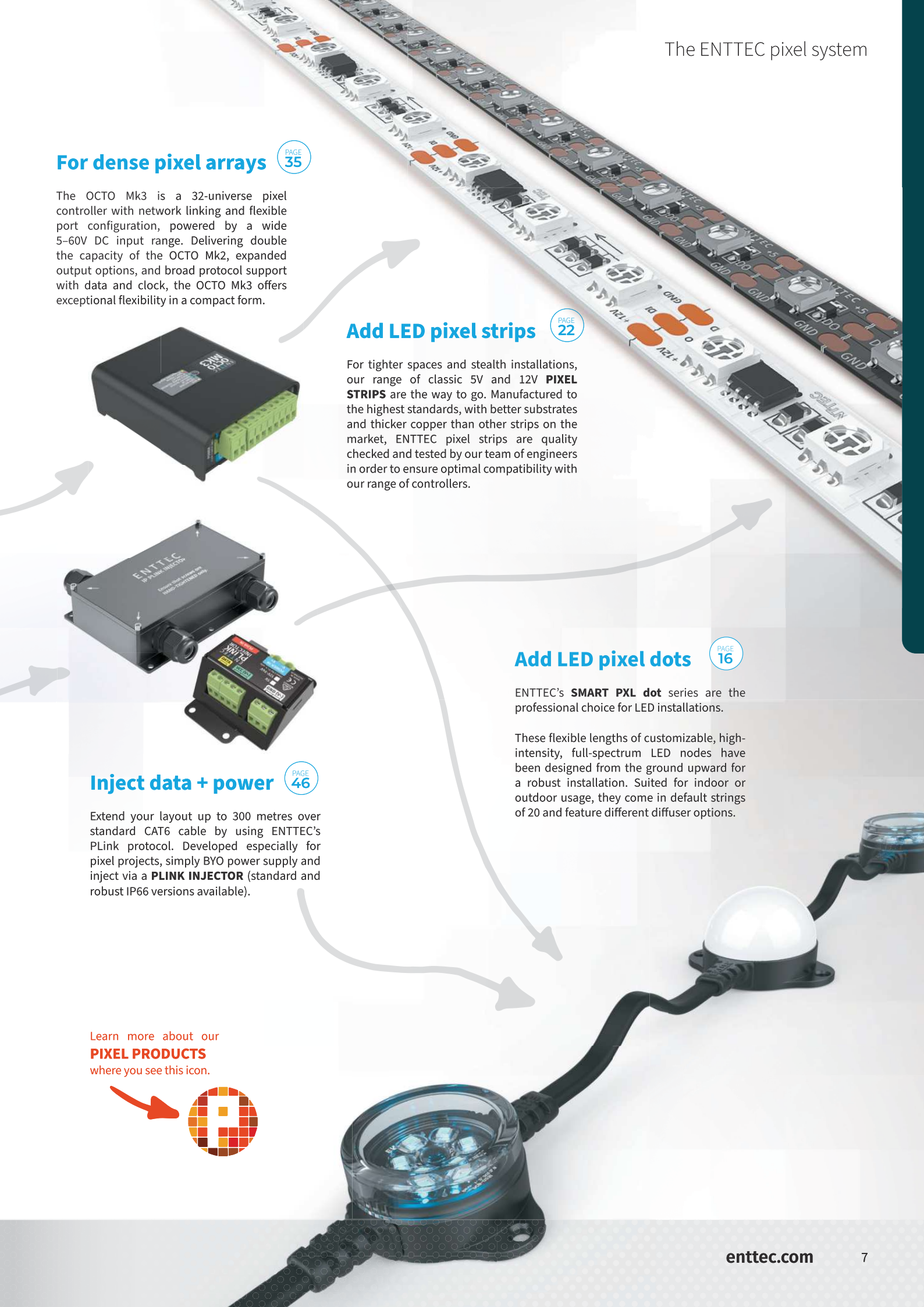



Smart home featuring ENTTEC S-Play, OCTO, ELM and RGBW pixel strips  
@ Launceston, Tasmania - by Zanetto Builders



Fitout for KFC at Sydney airport international terminal, featuring ENTTEC S-Play, OCTO and 4000+ SMART PXL40 LED dots.

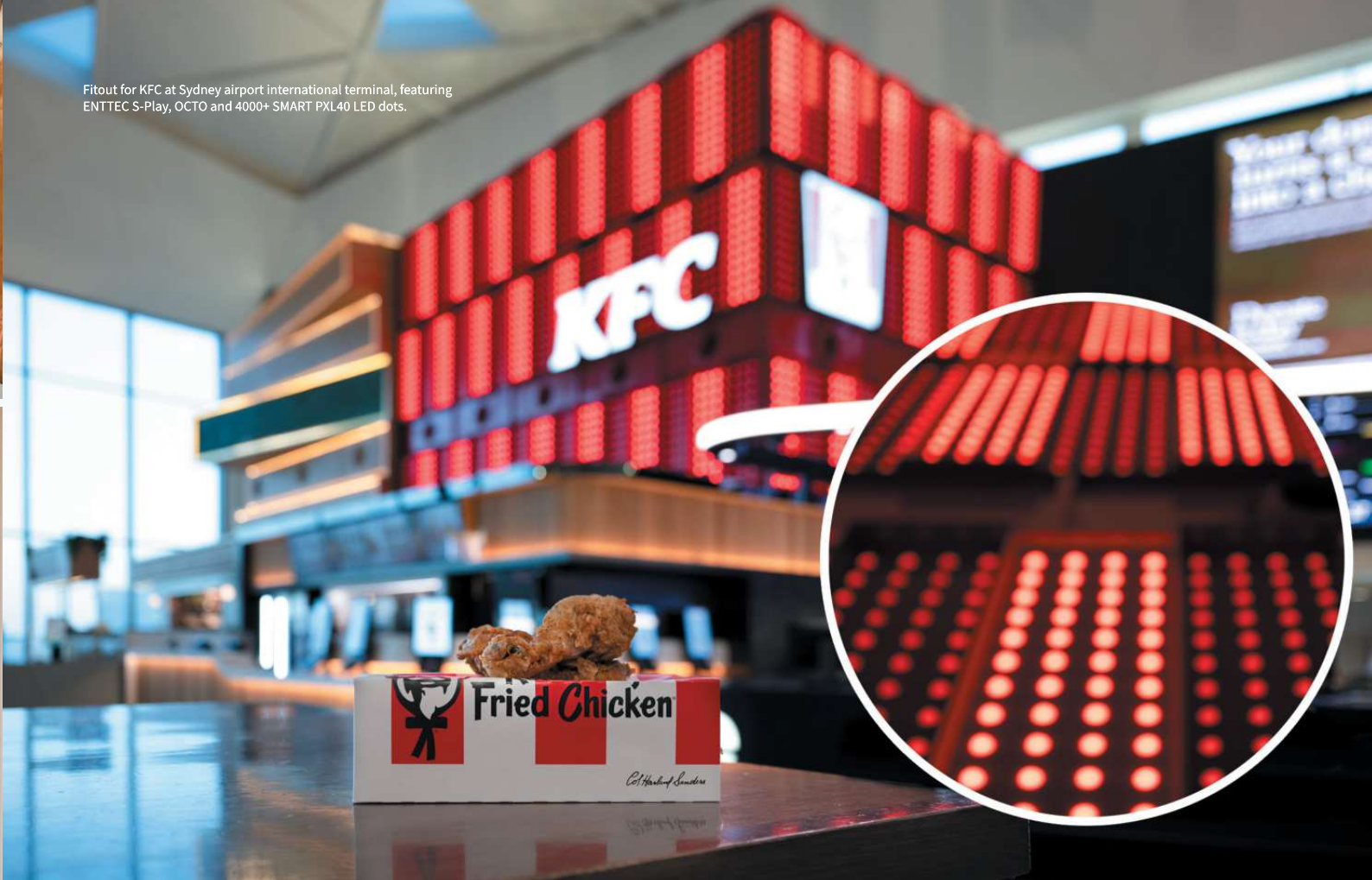

Show control

# S-PLAY series show controllers

With intuitive controls to record, edit, schedule and play cues, you don't have to be an experienced lighting designer or systems integrator to conjure up amazing performances using an S-PLAY show controller.

What's more, S-PLAY doesn't just handle light shows: it can trigger non-lighting events too, and present them through clean, custom control interfaces designed specifically for your space and users.

With four different models in the series, there's an S-PLAY to suit every situation. Select from the flagship S-PLAY SP1 with its 32U output, the impressive 16U LITE, compact 2U MINI or entry-level 1U NANO.

Whichever you choose, with countless applications from theatrical events to architectural design and smart building integration, automated show technology has never before looked so good, or been this easy to use day-to-day.

The ultimate solution for automated shows.



## S-PLAY SP1

SKU: 70092



- > User-friendly web interface
- > Supports remote access over the internet
- > Build custom touchscreen control layouts for any device
- > Trigger external events using a wide range of devices
- > Onboard LCD menu + USB for backing up shows
- > Expandable storage using the SD card slot
- > Connect and sync multiple S-PLAYs for extra control
- > EN-Case modular housing with many mounting options



### DATA/POWER IN



### DATA OUT



Record spectacular shows to play back on schedule or via interactive triggers ...

Whenever you want.

However you want.



The S-PLAY SP1's robust 1U half-width EN-Case modular hardware allows for a variety of surface, truss, rack and DIN rail mounting options straight out of the box thanks to its innovative design (mounting components included).

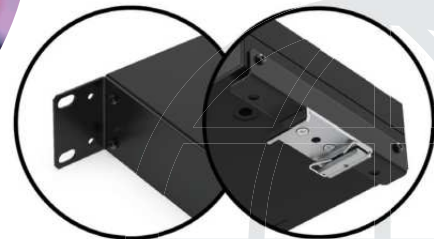

## RECORD.

Use the web interface or multiple remote triggering options to record up to 32 eDMX universes or 2 universes of physical DMX. Smart features such as loop detection ensure smooth playback, ready to be recalled via tailored control screens or automated schedules.

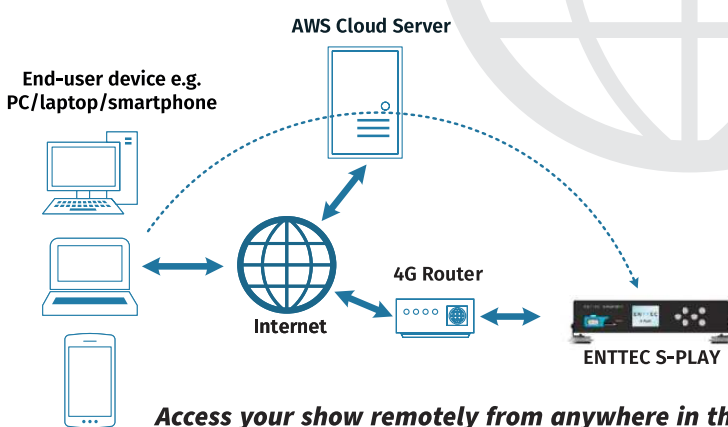

Access your show remotely from anywhere in the world via the internet using the S-PLAY SP1-1's secure SSH connection!



## EDIT.

Using the intuitive timeline editor, multiple recordings and scenes can be stitched together while adding triggers, events and custom controls, allowing S-PLAY to sit at the heart of any lighting, automation or venue control system.



## PLAY.

Play back multiple simultaneous shows from the internal scheduler, or trigger them instantly using beautifully simple custom interfaces on tablets, touch panels or computers, as well as via building automation software (e.g. Control4), iPad apps, pressure pads, motion detectors, push buttons and more.

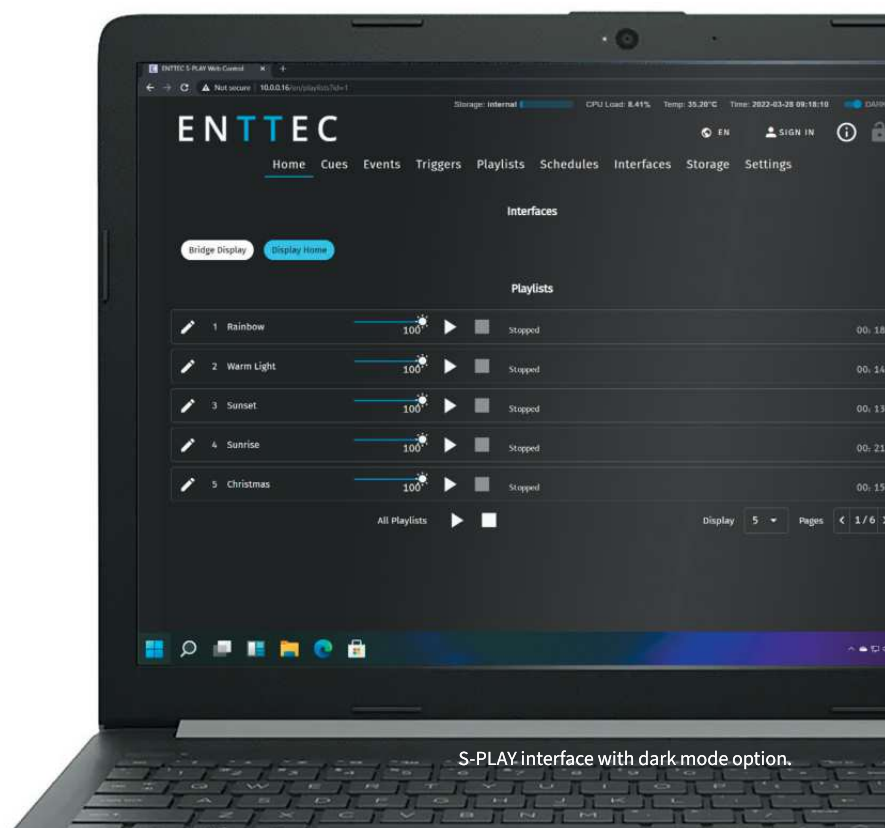

S-PLAY interface with dark mode option.

Show control

# S-PLAY LITE/MINI/NANO

SKU: 70094 / 70093 / 70095

## S-PLAY SP1-1

SKU: 70092

S-PLAY LITE 

SKU: 70094

ENTTEC



Explore the S-PLAY series on our website.

Talk to the ENTTEC team today and discover how integrating our S-PLAY show controllers can take your smart home setup to a whole new level.



S-PLAY MINI

SKU: 70093



S-PLAY NANO

SKU: 70095

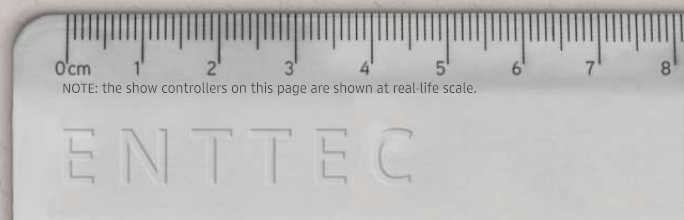

# Compare the S-PLAY series

	S-PLAY SP1 70092	S-PLAY LITE 70094	S-PLAY MINI 70093	S-PLAY NANO 70095
USITT DMX512-A playback	2U (1024 channels)	2U (1024 channels)	1U (512 channels)	1U (512 channels)
Art-Net/sACN universe playback	32U (16,384 channels)	16U (8,192 channels)	2U (1024 channels)	N/A
Max refresh rate (FPS)	Art-Net & sACN: 60 USITT DMX512-A: 44	Art-Net & sACN: 60 USITT DMX512-A: 44	40	40
Max playlist count	200	100	8	4
Max cue track per playlist	4	4	2	1
Max Cues	200	100	16	4
Max Triggers	200	150	16	8
Max Events	200	150	16	4
Max custom interface	10	5	1	N/A
OSC API	✓	✓	✓	✓
HTTP API	✓	✓	✗	✗
Scheduler	✓	✓	✗	✗
Network-based device management	✓	✓	✓	✓
Remote access (internet via 4G router)	✓	✗	✗	✗
Multi-sync	✓	✗	✗	✗
LED indicators	✗	✓	✓	✓
LCD + buttons	✓	✗	✗	✗
RS232 port	✓	✓	✗	✗
UL Listed	✗	✓	✗	✗
External/expandable storage	✓ - USB and SD card	✓ - SD card	✗	✗
Internal show storage capacity	8GB (~10 hours of 32U at 44fps)	8GB (~10 hours of 32U at 44fps)	1GB	1GB
Power input	DC jack (12V PSU & plugs included)	DC jack (12V PSU & plugs included)	2-pin Phoenix screw terminal	2-pin Phoenix screw terminal
Ethernet port / PoE	RJ45 / PoE IEEE 802.3af	RJ45 / PoE IEEE 802.3af	RJ45	RJ45
DMX port	2 x 5-pin XLR (female)	2 x 5-pin XLR (female)	Bi-directional 1 x 3-pin Phoenix screw terminal	Bi-directional 1 x 3-pin Phoenix screw terminal
Digital input	4 digital inputs + 1 GND + 1.5V (6-pin screw terminal)	4 digital inputs + 1 GND + 1.5V (6-pin screw terminal)	4 digital inputs + 1 GND (5-pin Phoenix screw terminal)	4 digital inputs + 1 GND (5-pin Phoenix screw terminal)
Relay	2 x relay 6-pin screw terminal (max limits, 50V DC)	2 x relay 6-pin screw terminal (max limits, 50V DC)	1 x relay (3-pin screw terminal)	1 x relay (3-pin screw terminal)



# S-PLAY I/O EXTENDER

SKU: 70096

Supercharge your S-PLAY experience by adding advanced input/output capabilities and integrate with existing setups for advanced smart lighting control and automated events.



The I/O Extender is the perfect partner for your S-PLAY SP1. Please note that the I/O Extender is not presently compatible with the S-PLAY LITE, MINI or NANO.

- > Dual Ethernet in/thru for seamless integration with existing networks
- > Easy configuration via your S-PLAY
- > Intuitive web interface for real-time monitoring and control
- > Create your own micro network
- > Flexible mounting options

#### DATA/POWER IN

- Digital input
- Analog
- 12-24V DC

#### DATA OUT

- Relay output



### Expand your control

**20 digital inputs:** connect more buttons, switches, or sensors for enhanced system control. **4 relays:** control external devices or automate actions with ease. **2 analog inputs:** broaden monitoring options, such as measuring light levels, distances, and introducing new compatible protocols.

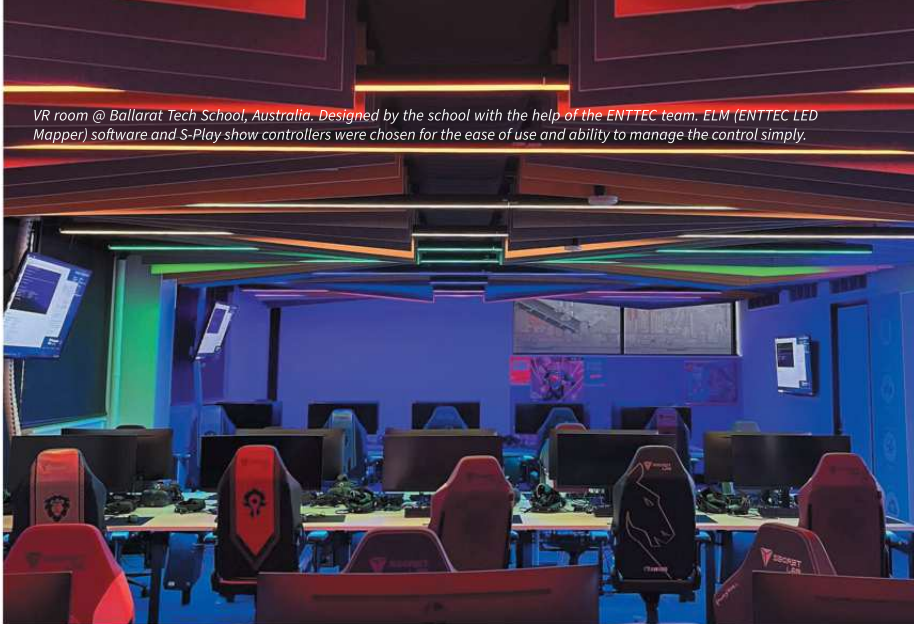

VR room @ Ballarat Tech School, Australia. Designed by the school with the help of the ENTTEC team. ELM (ENTTEC LED Mapper) software and S-Play show controllers were chosen for the ease of use and ability to manage the control simply.

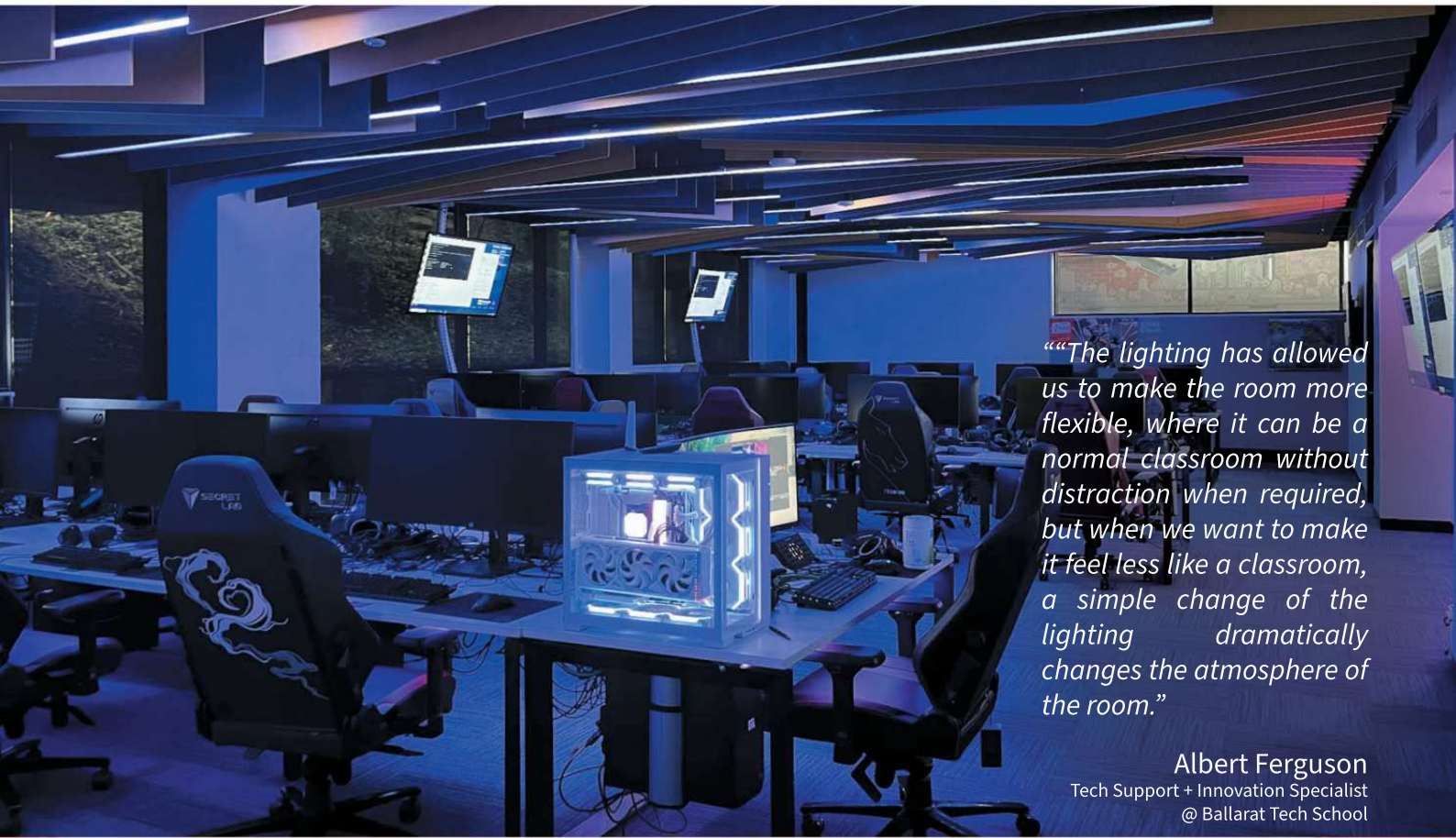

*“The lighting has allowed us to make the room more flexible, where it can be a normal classroom without distraction when required, but when we want to make it feel less like a classroom, a simple change of the lighting dramatically changes the atmosphere of the room.”*

**Albert Ferguson**  
Tech Support + Innovation Specialist  
@ Ballarat Tech School

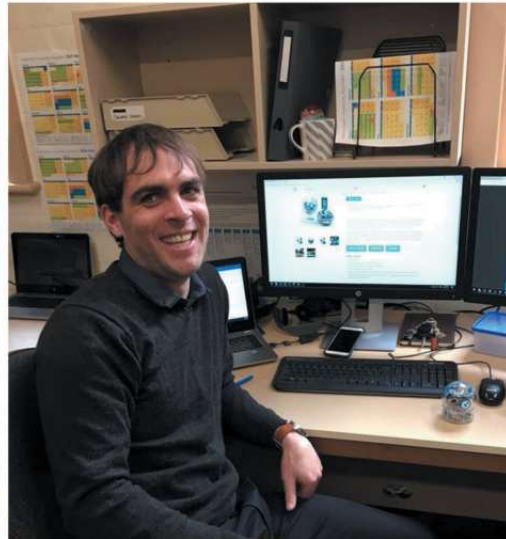



# SMART PXL LED DOTS

PXL 100x25: 73030 / PXL-60: 73050 / PXL-40P: 73040 / PXL40 METAL: SKU: 73010-73012



Robust and reliable, ENTTEC's 16-bit resolution, individually-addressable SMART PXL dot series are designed to withstand the harshest environments.

With many customisable features, SMART PXL dots can be configured into any conceivable shape. Engineered to create spectacular, crisp lighting effects, they add a stylish design element to any architectural, commercial or entertainment project

## Why SMART PXL dots?

- > Flexible, long-lasting and robust
- > Highly customisable
- > Smooth 16-bit dimming resolution
- > IP67 rating for outdoor use
- > Improved thermal management compared to pixel tape
- > Visual appeal as a conspicuous feature

## Google Pixel Wall

Interactive customer experience for Google's flagship retail stores, designed and installed by Grumpy Sailor using ENTTEC pixel dots.

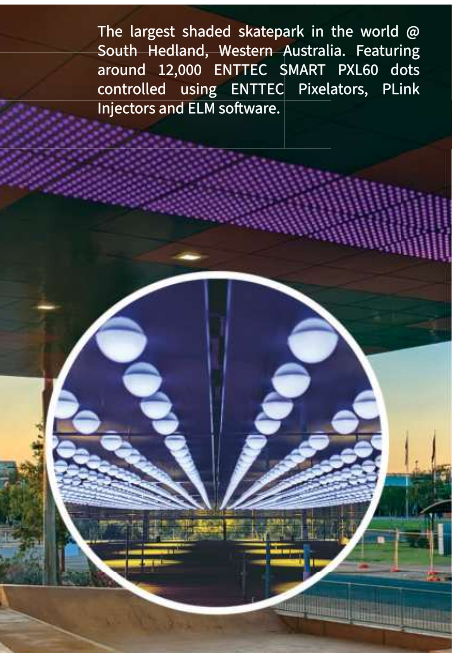
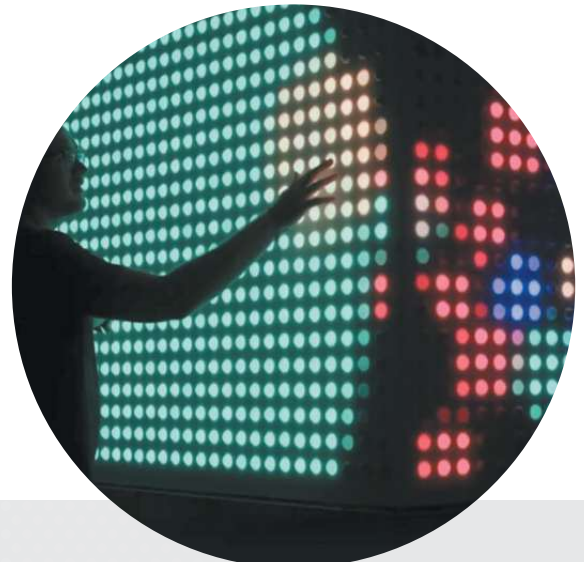

The largest shaded skatepark in the world @ South Hedland, Western Australia. Featuring around 12,000 ENTTEC SMART PXL60 dots controlled using ENTTEC Pixelators, PLink Injectors and ELM software.



# Lens options + light output

## SMART PXL 100x25

Max lumens - 24V: 39.2 RGB / 87.1 RGBW  
Max lumens - 48V: 38.3 RGB / 82.5 RGBW

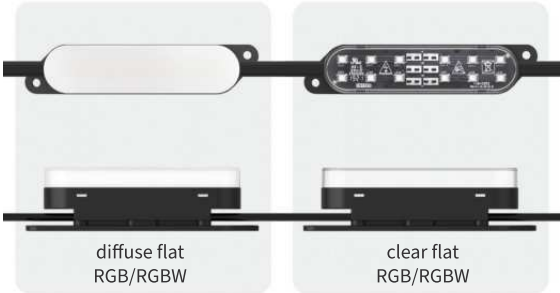

## SMART PXL-60

Max lumens - 24V: 65.0 RGB / 110.4 RGBW  
Max lumens - 48V: 63.5 RGB / 101.4 RGBW



## SMART PXL-40P

Max lumens - 24V: 29.1 RGB / 41.5 RGBW

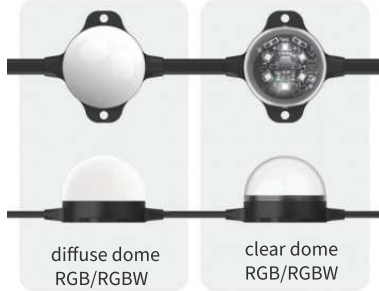

## SMART PXL40 METAL

Max lumens - 24V: 19.3 RGB



## HI-RES.

16-bit native for an ultra-smooth dimming curve and colour-mixing detail that will truly wow your audience, delivering refined fades, accurate low-level control and consistent performance across even the most demanding pixel installations.



## BRIGHT.

Each SMART PXL node contains premium LEDs, giving an impressive lumen output with different lens options, while thick, tinned copper cabling reduces voltage drop over the length of each string.



## ROBUST.

SMART PXL dot cases are made from a selection of the finest and most durable quality materials available. With a 3-year warranty as standard, these dots are seriously engineered to stand the test of time.



## SECURE.

Offering outstanding protection against moisture and corrosion, SMART PXL internal components are fully-potted (encased in resin) for waterproofing as well as resistance to shock and vibration.





### SMART PXL 40 dots

- Flexible strings of 41.5mm LED nodes
- RGB or RGBW LEDs • 24V system
- injection-molded PVC case in black or white

### SMART PXL 100x25 dots

- Flexible strings of 100mm x 25mm nodes
- RGB or RGBW LEDs • 24V or 48V system
- injection-molded PVC case in black or white



### SMART PXL 60 dots

- Flexible strings of 55.5mm LED nodes
- RGB or RGBW LEDs • 24V or 48V system
- injection-molded PVC case in black or white

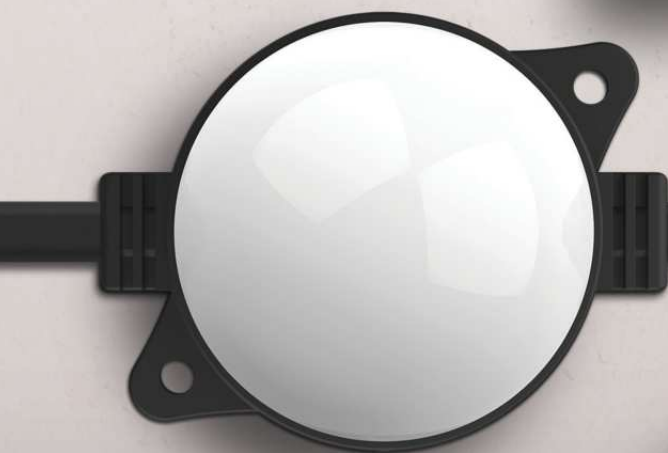

### METAL SMART PXL 40 dots

- Flexible strings of 41.5mm LED nodes
- RGB LEDs • 24V system
- Marine-grade anodised aluminium case (black only)



- For professional applications
- Colour-changing LED pixels
- Rich hues & ultra-smooth dimming
- Custom lengths made to order

*Talk to our friendly project consultants and learn how integrating SMART PXL dots can take your project to a whole new level.*

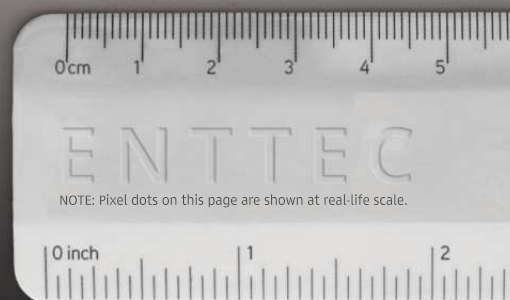

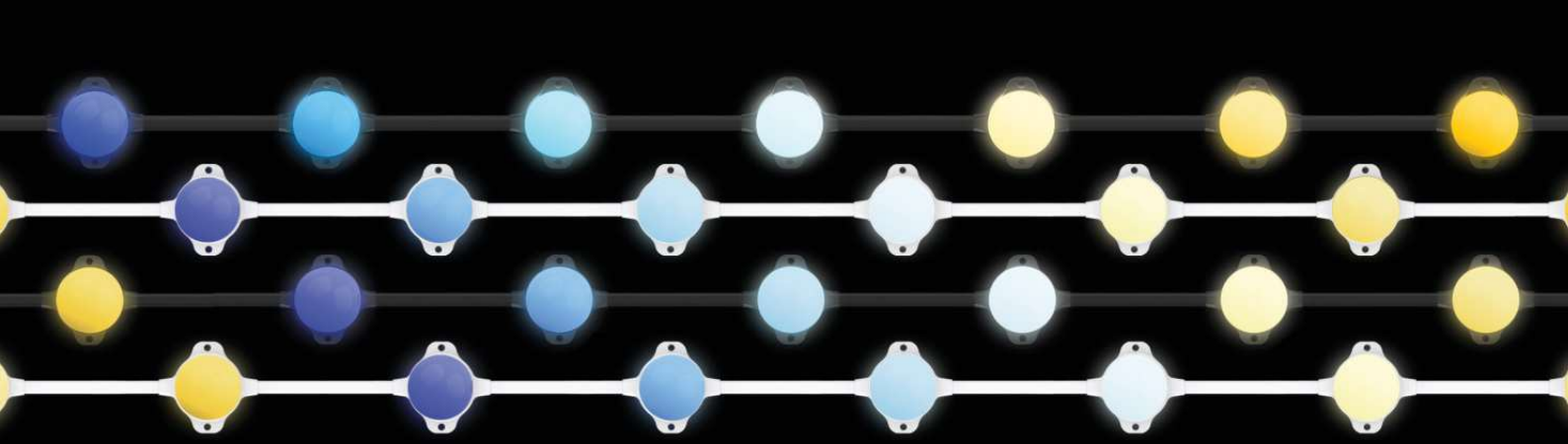

# ENTTEC

## SMART PXL LED dot series

---

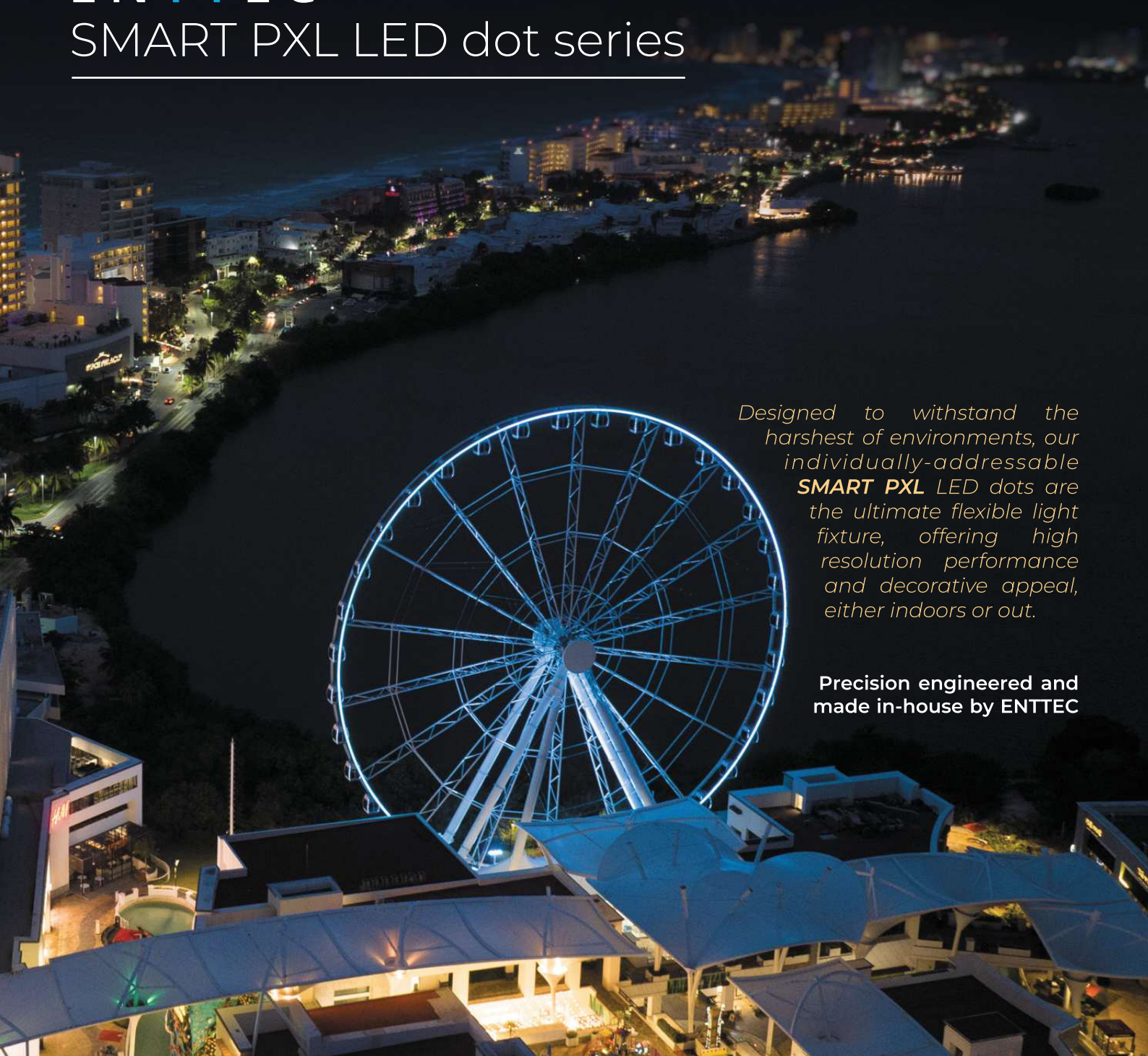

*Designed to withstand the harshest of environments, our individually-addressable **SMART PXL** LED dots are the ultimate flexible light fixture, offering high resolution performance and decorative appeal, either indoors or out.*

**Precision engineered and made in-house by ENTTEC**

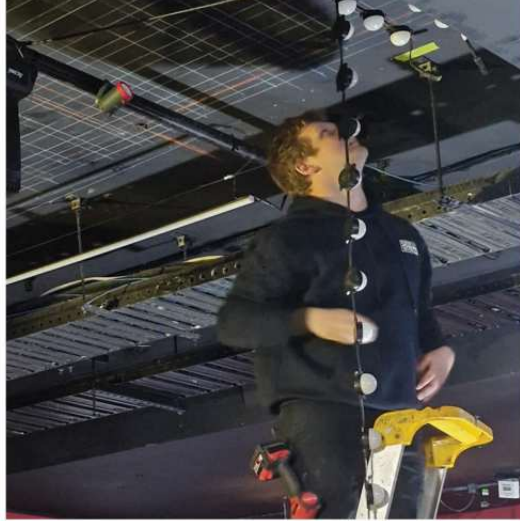



Since the 1950s, the Prince Bandroom has been Melbourne's heartbeat for live music, hosting legends from Nick Cave and Midnight Oil to Billie Eilish and Glass Animals. It's more than just a venue, it's a living testament to the city's vibrant musical heritage.

The main feature of its latest makeover by Lotron Electrical is an LED pixel ceiling created with hi-res ENTTEC Smart PXL 60 dots, controlled by ENTTEC OCTOS and ELM software.

Nightlife photography by Giulio Lavenuta





# LED PIXEL STRIPS

SKU: SEE TABLE



Manufactured to the highest standards, our digital pixel strips are designed, quality checked and tested by our team of in-house engineers. Available in different voltages, configurations and PCB colours, there's a strip for virtually every situation.

- > True Colour display
- > 800 kbps data transmission rate
- > Custom PCB design to minimise the effects of voltage drop
- > Adhesive backing for quick and easy installation
- > Operating temperature 5°-50°c
- > Each variety available in 5m reels

We use thicker copper (3oz/sqft) and better quality substrates than other strips on the market, meaning:

- > Extra durability
- > Safer (better heat dissipation)
- > Improved current flow
- > Less voltage drop (which means less power re-injection required)

SKU	TYPE	MAX LUMENS	PCB COLOUR	VOLTAGE	LEDs / m
8PXA60-RGB-5V-B	Individually-addressable RGB LEDs	259.4	Black	5V	60
8PXA60-RGB-5V-W	Individually-addressable RGB LEDs	259.4	White	5V	60
8PXA60-RGBW-5V-B	Individually-addressable RGBW LEDs	588.8	Black	5V	60
8PXA60-RGBW-5V-W	Individually-addressable RGBW LEDs	588.8	White	5V	60
8PXA60-RGB-12V-B	Individually-addressable RGB LEDs	188.2	Black	12V	60
8PXA60-RGB-12V-W	Individually-addressable RGB LEDs	188.2	White	12V	60
8PXA60-RGBW-12V-B	Individually-addressable RGBW LEDs	1088.0	Black	12V	60
8PXA60-RGBW-12V-W	Individually-addressable RGBW LEDs	1088.0	White	12V	60
8PXB60-RGB-12V-B	3 LEDs-per-pixel addressable RGB	349.4	Black	12V	60
8PXB60-RGB-12V-W	3 LEDs-per-pixel addressable RGB	349.4	White	12V	60
8PXB60-RGBW-12V-B	3 LEDs-per-pixel addressable RGBW	655.6	Black	12V	60
8PXB60-RGBW-12V-W	3 LEDs-per-pixel addressable RGBW	655.6	White	12V	60

**ENTTEC 8PX SERIES: the very latest in LED technology**

An engineering marvel: compact yet powerful 8PX series strips shown at their at real-life scale (PCB width: 10mm)

A stunning light sculpture and its beautiful reflection on the tranquil waters of Skovsøen lake in Odense, Denmark ~ Conceived and created by Chaos Engine using 5,400 LED pixels.



**5V RGB PIXEL STRIPS**

8PXA60-RGB-5V-B



8PXA60-RGB-5V-W

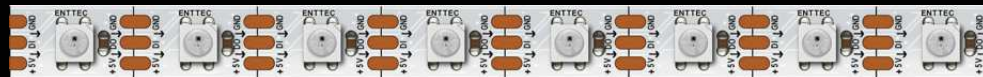

**5V RGBW PIXEL STRIPS**

8PXA60-RGBW-5V-B



8PXA60-RGBW-5V-W



**12V RGB PIXEL STRIPS**

8PXA60-RGB-12V-B



8PXA60-RGB-12V-W



**12V RGBW PIXEL STRIPS**

8PXA60-RGBW-12V-B

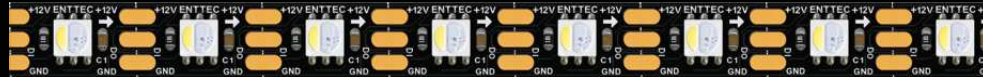

8PXA60-RGBW-12V-W

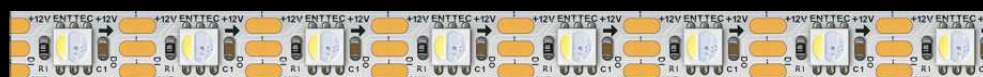

**12V RGB LONG-RANGE PIXEL STRIPS**

8PXB60-RGB-12V-B



8PXB60-RGB-12V-W



**12V RGBW LONG-RANGE PIXEL STRIPS**

8PXB60-RGBW-12V-B



8PXB60-RGBW-12V-W





# NEON FLEX

SKU: 73060



The ultimate LED lighting solution that combines flexibility, durability, and ease of installation. Made from high quality silicone, this waterproof LED strip is designed to handle any environment.

ENTTEC Neon Flex allows for easy shaping and contouring, enabling you to create amazing, unique designs. Whether you need a horizontal or vertical bend, or a wide or focused beam angle, we have a Neon Flex design to suit your requirements.

Installing Neon Flex is a breeze with our range of cable and power connector options. In addition, with accessories for surface or recessed mounting, Neon Flex ensures a sleek and professional finish.

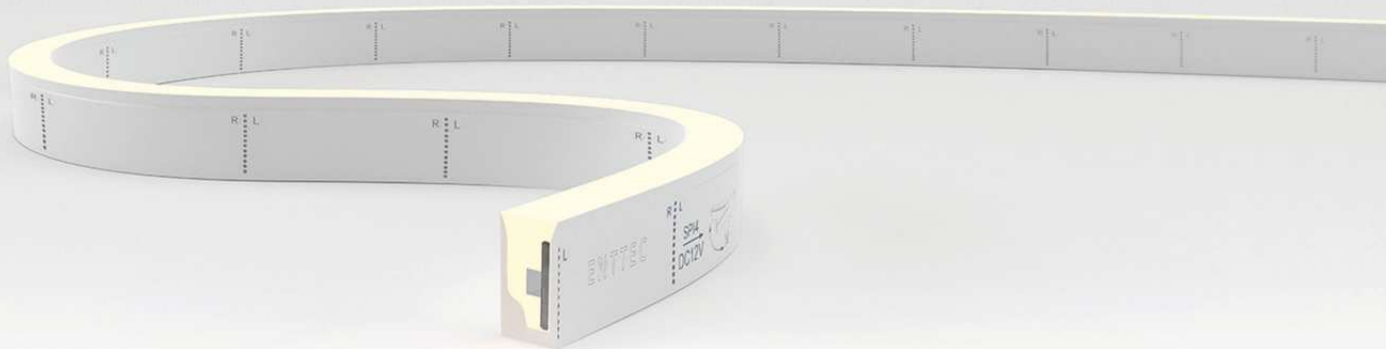

- > For professional applications
- > Made from high quality silicone
- > Horizontal or vertical bending varieties
- > DMX, SPI, and non-addressable single colour, tuneable white or RGBW versions
- > Colour-changing, smooth-dimming LEDs
- > Custom lengths made to order



DATA/POWER IN





ENTTEC LED lighting @ PLC Performing Arts Centre, Melbourne ~ by COX Architecture

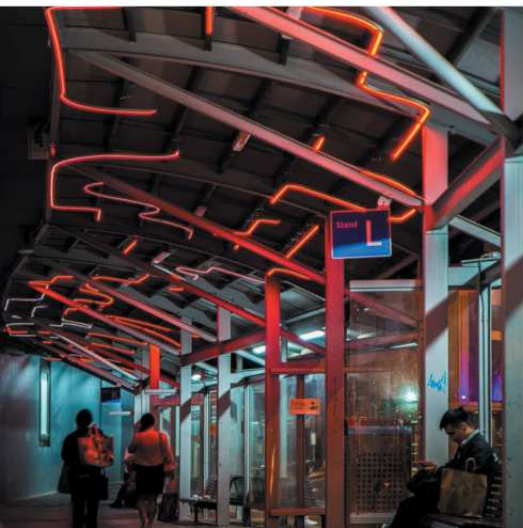

"Interwoven" in Hurstville, NSW, Australia, featuring interactive LED Neon Flex controlled by an ENTTEC S-PLAY ~ design and installation by Lawrence Liang Public Art / Ali Megahed

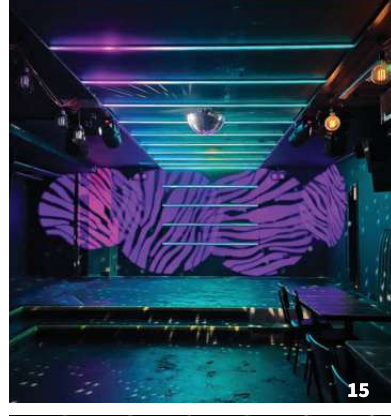
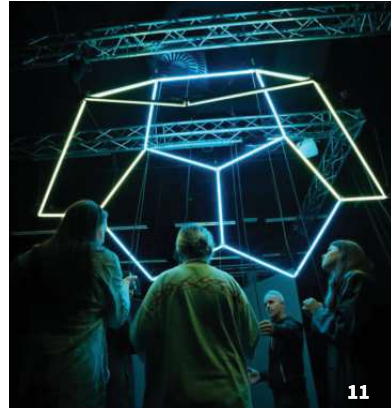
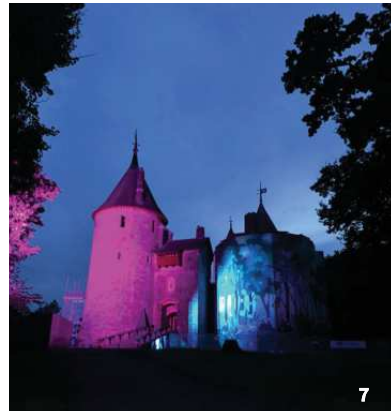
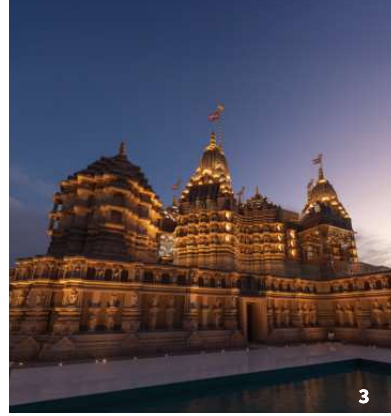
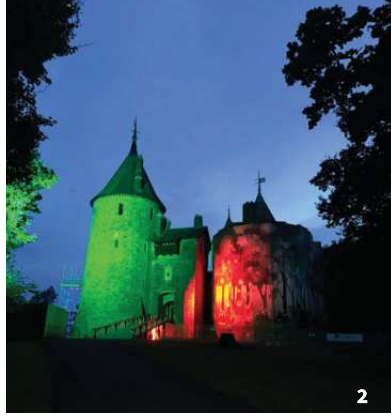

*"Thank you ENTTEC for creating a great system and for the support you offered to back it up."*

Sierra Audio Solutions



*Burning Man bird installation by Sierra Audio Solutions using ELM and the Pixelator system to control 7000 RGB LED pixels.*



*Belgian artist Arne Quinze created 'Oasis' - a massive installation in the middle of the vast Riyadh desert. Lighting designers Fisheye used two ENTTEC S-PLAY SP1s and ELM software to bring the 47,000 LEDs to life at night.*



*Opposite page: a variety of recent lighting projects and installations from around the world, all created by talented designers and made possible thanks to ENTTEC software, controllers and LED fixtures.*

*Figures 9, 14, and 16 are the work of US-based lighting designer Butch Thomas*

*Figure 11 is the work of null\_collective*

*Figure 12 is the work of OCL Architectural Lighting at BoA Stadium USA*

*Figure 19 is SpaceX Dragon Cargo Space Craft by Bridgewater Studio*



ELM @ Ipswich City Council tower, Queensland, Australia

**LIVEDESIGN**  
**LIGHTING**  
**CONTROL SOFTWARE**  
**PRODUCT**  
**OF THE YEAR WINNER**



# ENTTEC LED MAPPER (ELM) 2025

SKU: 70581 (Licences: ENTRY: 4U / STANDARD: 16U / ADVANCED: 48U / PROFESSIONAL: 96U / SUPER: 256U / ULTIMATE: 512U / ARCHITECTURAL: 1024U / ELITE: 2048U / EXTREME: 8192U)

With a whole heap of new features and improvements added for 2025, let your creativity soar with the versatility, power and precision of ENTTEC's LED mapping software.

- > Highly-intuitive interface
- > Huge generative effects library
- > Audio reactive mix feature
- > 2D & 3D mapping
- > Control up to 8192 Universes
- > Upgrade your license at any time
- > Proven track record of high-profile projects

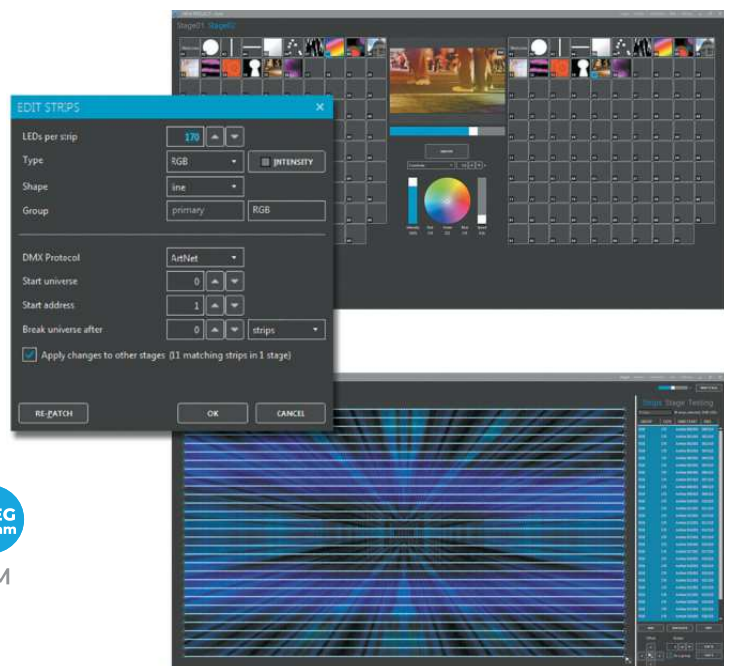

**DATA IN**



**DATA OUT**



**PLATFORM**



<sup>+</sup>using DMX USB Pro

**RECOMMENDED SYSTEM REQUIREMENTS:** Windows 10 or 11, quad core 3.5 GHz CPU, 8 GB RAM, NVIDIA GeForce 900 series or NVIDIA 10 series or better, SSD hard drive.

ELM combines raster-based media with vector-based, scalable and repositionable objects to represent your LED strips. Choose whether your LEDs are in a line, curve or full loop with just a few mouse clicks - then stretch, resize or move them around on-screen to match your strips in the real world.

Load and play back 4K or higher video files, generative effects, still images or display live streams using NDI, Spout, MPEG streams or physical capture cards. Create sequences and steps (cues) and easily trigger them remotely via DMX, OSC and HTTP. You can also schedule your sequences, which allows for the syncing of multiple stages - perfect for projects with many layers, such as a 3D structure.



ELM @ SAINT Private Social Club, St Kilda, Australia  
Lighting design by Kit Webster



ELM @ Electric Daisy Carnival, Las Vegas

*"After reviewing a huge amount of options we found ELM to be the most intuitive and reliable application for the needs. It's clearly been designed by a team of people with a deep understanding of how a piece of software like this is actually used in the field. For a 6-week run, every night of the week during the British winter, it was rock solid."*

Chris Evans-Roberts  
Founder & Creative Director, ITHACA



ELM @ Kew Gardens, London, UK ~ by ITHACA

With output support for Art-Net, sACN and KiNet, ELM works with a large number of ENTTEC and 3rd party lighting products. You can easily integrate ELM with your favourite control software using DMX, Art-Net, sACN, ENTTEC's DMX USB Pro, OSC or HTTP. ELM supports a wide range of LEDs such as RGB, BRG, RGBW, RGBWA and white in either 8- or 16-bit profiles.

## Optional support

ELM software runs on **PC/Windows systems ONLY**, but it can be controlled remotely by iOS devices using 3rd party software with the remote API's already integrated as standard.

**Touch OSC** by Hexler can allow recalling of states, or for a more complete implementation, **ON LX's Ctrl for iPad** allows ELM to be controlled as part of a wider installation with live thumbnails, creating a perfect customisable front-end interface for any installation requiring efficient editing on the run.





**ELM**  
ENTTEC LED MAPPER  
**IN ACTION**

From independent hobbyists to professional lighting designers, ENTTEC LED Mapper (ELM) is being used worldwide to bring pixel-based installations to life, across venues, façades, artworks and immersive environments.

ELM turns LEDs into a visual canvas, allowing designers to map, animate and control individual pixels with precision and scale. The result is dynamic, flowing light that adds motion, texture and impact, helping installations stand out and evolve far beyond static lighting.



Indiana, USA, playground project by Lucky Climbers ~ featuring ELM and 66x OCTO pixel controllers



Spanish lighting engineer Mxim Morales uses ELM @ Barcelona hotspot Shko.



ELM @ Nobu, One Za'abeel, Dubai, UAE

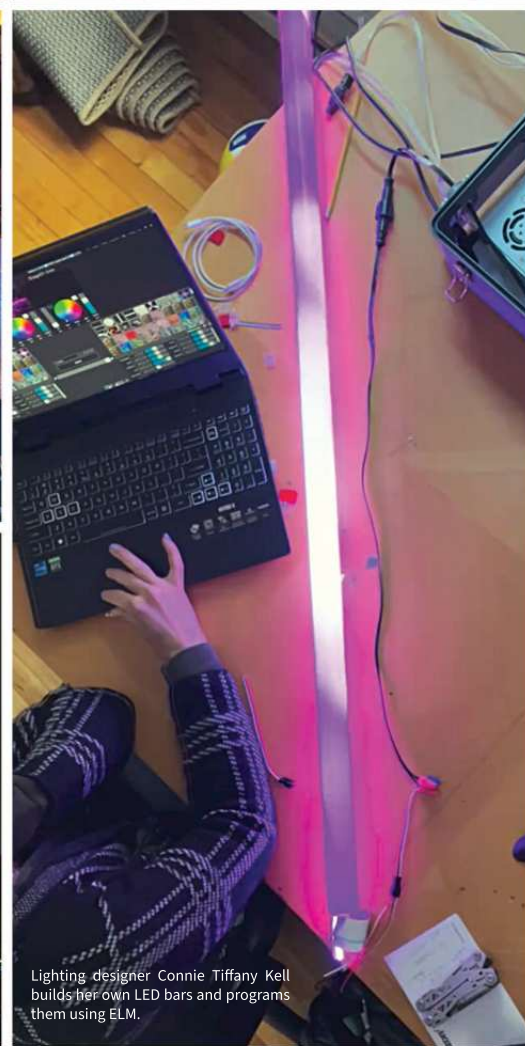

Lighting designer Connie Tiffany Kell builds her own LED bars and programs them using ELM.



ELM powers the stageshow for a headlining set by K-pop legends Blackpink at California's Coachella Festival.



ELM @ Chimelong Water Park, Guangzhou, China

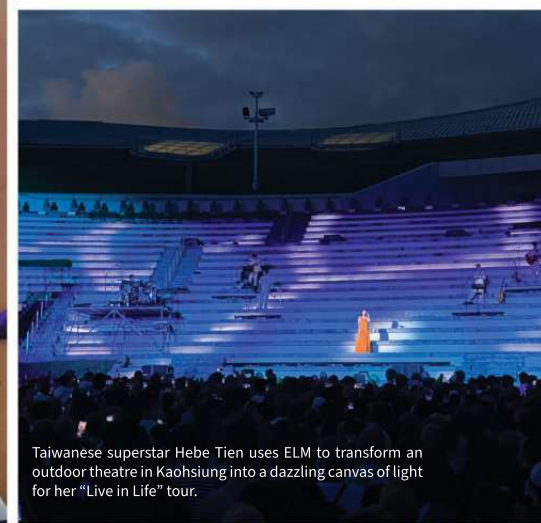

Taiwanese superstar Hebe Tien uses ELM to transform an outdoor theatre in Kaohsiung into a dazzling canvas of light for her "Live in Life" tour.



Designers Bland Hoke and Dan Sanford with their ELM-powered installation at Aurora restaurant in Wyoming, USA.

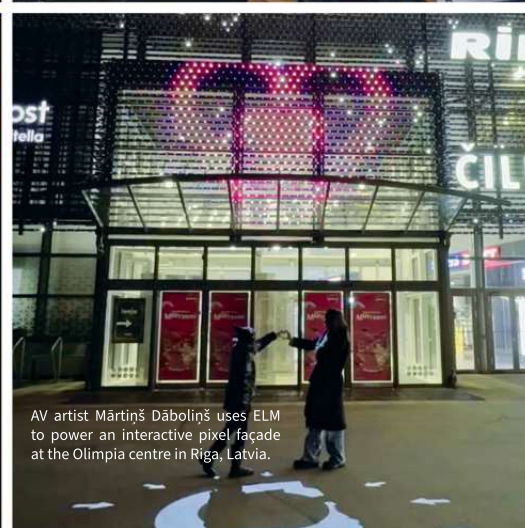

AV artist Mrtiņš Dboliņš uses ELM to power an interactive pixel faade at the Olimpia centre in Riga, Latvia.



Junior Major uses ELM to map interactive LED constellations for the Terracotta Warriors exhibition at WA Museum, Perth.



**LED  
DOTS**

+

**S-PLAY**

smart light show controller



**The perfect pixel pair.**

Engineered to perfection by **ENTTEC**





# OCTO @WORK

This is one of the longest suspension footbridges ever constructed and you'll find it spanning a bayside inlet in the coastal city of Ulsan, South Korea.

The LED pixel installation has been mapped using ENTTEC LED Mapper (ELM), controlled by an S-PLAY and fed into a series of OCTOs and DIN Ethergates.

This spectacular light show can be seen at night from the opposite side of the bay.

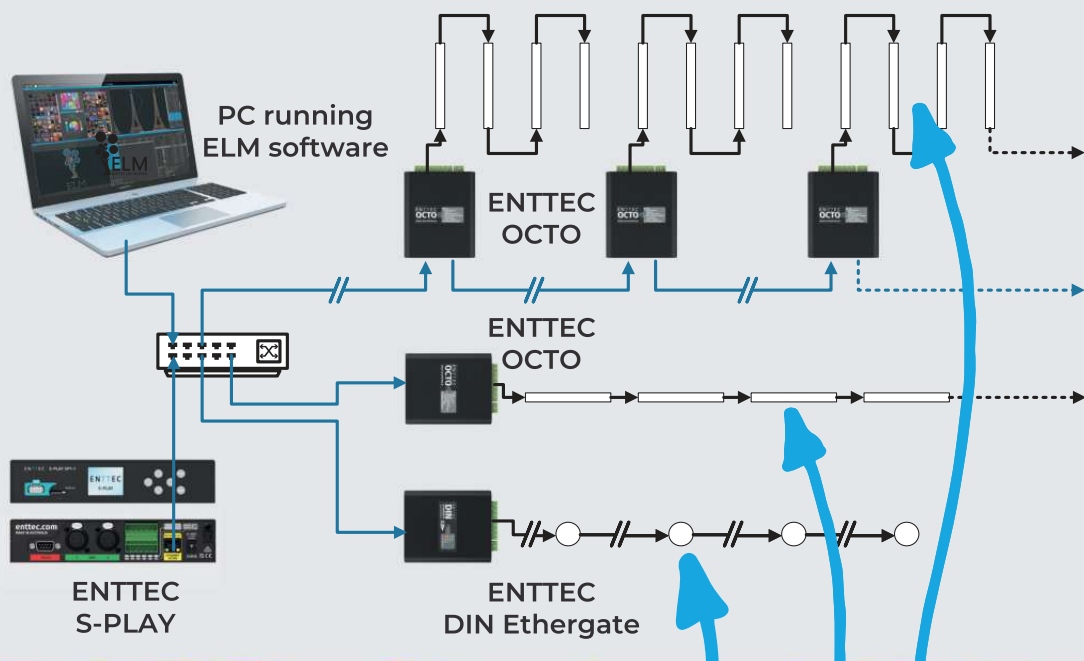

Suspension footbridge in Daewangam Park, Dong-gu, Ulsan, South Korea.

Engineering: Daejoo Do, Kyungho Park, Benjamin Moon  
Lighting Design: Soohong Baek, Kwanghee Cho, Hyukjun Kwon  
Media Artists: Yousuk Kim, Jinpoong Lee



# OCTO MK3

SKU: 71522



FREE SOFTWARE



PIXEL PRODUCT

A quad-output eDMX-to-LED pixel controller with overdrive and flexible port configuration, the OCTO Mk3 unleashes up to 32 universes of SPI data from a compact, 4-module DIN-rail form factor. Engineered for pro-grade reliability, it brings unprecedented control power to architectural, commercial and entertainment projects.



Designed for rapid deployment, it supports Art-Net, sACN, ESP and KiNet protocols and more than 20 industry-standard SPI types, while offering advanced options such as Port Sync and built-in FX for standalone playback.

- > 32 universe capacity in compact form
- > Flexible port configuration with split & overdrive modes
- > Dual Ethernet for daisy-chaining
- > Live + Standalone FX engine operation
- > Wide 5-60V input + easy web setup



DATA/POWER IN

Art-Net   KiNET   sACN   ESP   5-60 V

DATA OUT

Wide range of Pixel protocols   Network pass-through   Custom Protocol Creation



# OCTO MK2

SKU: 71521



A dual-output eDMX to LED pixel data converter, the OCTO MK2 is a robust and reliable installation-grade device that can output up to 16 universes of data. Connecting directly to your pixel fixtures, the OCTO MK2 is engineered to take any architectural, commercial or entertainment project to the next level.

Designed for ultra-fast deployment of LED strips and pixel dot systems, the OCTO MK2 is compatible with a wide range of input and output protocols - and you can even create your own custom output protocols.

- > Capable of network chaining
- > Huge list of supported SPI protocols or create your own protocols
- > Variable voltage input range of 4-60V
- > TS35 DIN rail or surface mount options
- > 'Identify' button + LED for easy testing

DATA/POWER IN

Art-Net   KiNET   sACN   ESP   4-60V

DATA OUT

Wide range of Pixel protocols   Network pass-through   Custom Protocol Creation





# OCTO LITE

SKU: 71523



A dual-output eDMX to LED pixel data converter, the OCTO LITE is a compact, installation-grade controller capable of outputting up to 8 universes of pixel data. Designed for space-efficient projects, it connects directly to pixel fixtures and delivers reliable performance for architectural, commercial, and entertainment applications.

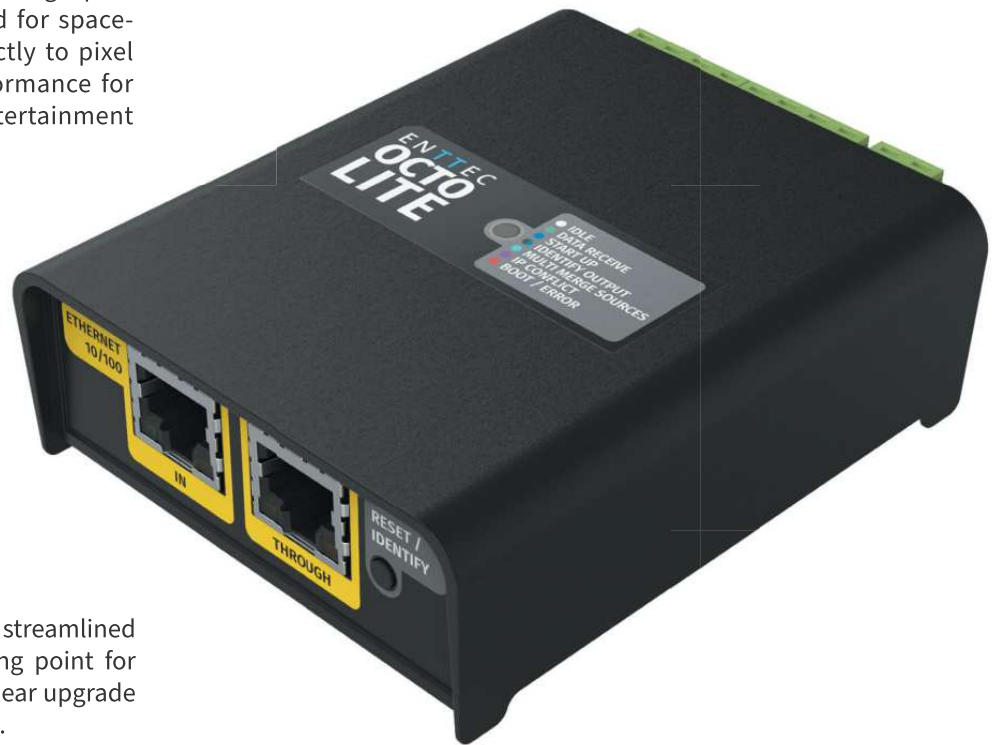

Offering the core OCTO workflow in a streamlined format, the LITE is the ideal starting point for compact pixel installations, with a clear upgrade path to MK2 or MK3 as projects scale.

- > Up to 8 universes of pixel output
- > Dual Ethernet ports for daisy chaining
- > Wide range of supported SPI protocols or create custom protocols
- > Flexible 5–60V DC power input
- > TS35 DIN rail or surface mount options

#### DATA/POWER IN



#### DATA OUT





The House of Amouage perfume boutique in the Dubai Mall - inspired by the magnificent dawns on the Sayq Plateau and the rose terraces of Oman.

Designed by Renaud Salmon and architects Héroïne, installers Connectiv used ENTTEC Smart PXL 60 dots controlled by OCTO and S-PLAY devices.

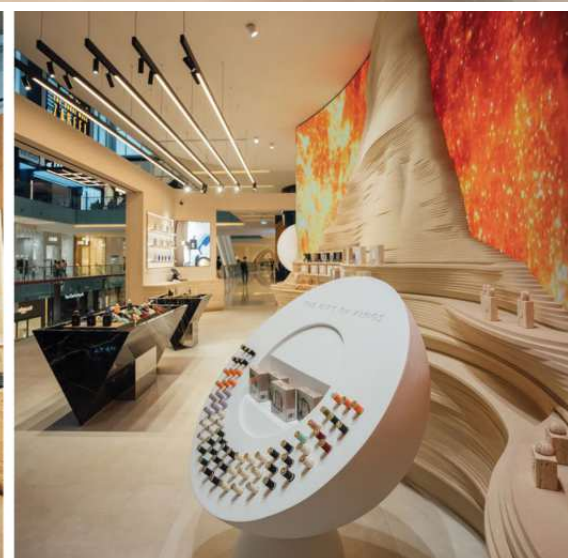



Private garage installation in Melbourne, Australia ~  
Designed by Poat Designs and Yestalgia. Lighting installed by Lotron Electrical, featuring dynamic lighting states programmed using ELM software (including audio-reactive shows for true 'party mode'). Everything is triggered on demand by an S-PLAY SP1 show controller, and fed through a series of 9 OCTOs into ENTTEC 12V RGBW pixel strips.





# DIN PIXIE

SKU: 73539



A smart, cost-effective lighting control solution, the DIN PIXIE is a compact, 2-Universal DMX to LED pixel protocol converter and standalone player, engineered to take any architectural, commercial or entertainment project to the next level.



- > 5-48V DC input range
- > Control up to 340 RGB or 256 RGBW pixels per output
- > Supports a wide range of strips/dots
- > Pre-program or run live
- > 2 x DMX ports (in only, not daisy chain)
- > USB control API for custom applications

DATA/POWER IN



DATA OUT



A series of DIN PIXIE drivers are integral to operation of the enigmatic centrepiece installation for *Decoded: 75 Years of the Australian Signals Directorate* @ National Museum of Australia, Canberra.



Lighting design & images by Adam Meredith @ MEGS lighting.

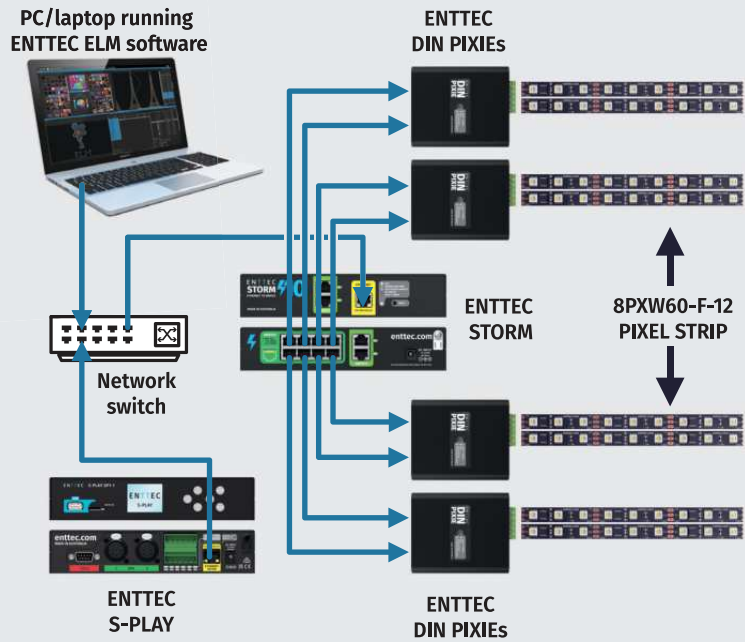



Storm 8 (controlled facade lighting as well as an interactive water installation inside) @ Hyundai Pavilion, Pyeongchang Winter Olympics ~ by iart



ENTTEC S-Play, Pixelator Mini, PLink Injectors and 8PL60-F-12 pixel strip @ Ballarat Boom Box DJ booth project, Victoria, Australia ~ by Illumidy



ELM @ GLOW festival (LumenUs installation) ~ by Eindhoven University of Technology



# PIXELATOR MINI

SKU: 70067



An installation-grade Ethernet pixel converter designed to make control of LED pixel dots and strip simple. Using Overdrive Mode, the Pixelator Mini is capable of outputting a total of 32 Universes (up to 4 Universes per port), with perfect synchronisation across each.



The Pixelator Mini and Mini Mk2 are engineered to take domestic and commercial smart lighting installations to a whole new level.



Convenient and easy to use, PLink outputs using RJ45 connectors (ANSI 1.27) are universally familiar to installers and require no soldering.

- > Ethernet connection (10/100 Mbps)
- > Compatible with many pixel protocols
- > 8 x 4-Universe PLink ports
- > Output protocol customisation
- > Intuitive configuration via web browser
- > EN-Case modular housing for easy rack, surface or DIN-rail mounting

#### DATA/POWER IN



#### DATA OUT



Big Star condo @ Seattle, Washington, USA

Architect: DeForest Architects (Team: John DeForest, Mark Slivka)  
 Interior Design: Grayscale Design Studio  
 Lighting: Brian Hood Lighting Design  
 Contractor: Lockhart Saver  
 Photography: John Granen



# PIXELATOR MINI MK2

SKU: 70068



With 16 ports outputting up to 8 Universes each in Overdrive Mode to give you a total of 128U, the Pixelator Mini Mk2 is truly your supersized version of the classic original Mini.

What's more, its Port Sync technology ensures perfect synchronisation across large-scale and complex lighting installations with high data transfer demand.



Pixelator Mini and PLink Injectors in action @ Kingpin Crown, Melbourne, Australia

This project also features an S-PLAY SP1 and 96m of ENTTEC RGBW pixel strip.

Lighting design: Ambience Lighting



Features the same reliable RJ45 ports as the classic Mini ... but twice as many of them, and *double* the output per port of the Mini in Overdrive Mode.

- > Dual Ethernet ports (10/100 Mbps) enable daisy-chain connectivity
- > Compatible with many pixel protocols
- > 16 x 8-Universe PLink ports
- > Port Sync to eliminate inconsistencies and ensure precise effects
- > Ideal for large-scale data transfers

### DATA/POWER IN



### DATA OUT





Two projects by Colorado-based creators Dark Moon Designs, both using the ENTTEC Pixelator/PLink system: "Electric Forest" installation and DJ booth design for Two Friends' Heatwave Tour.

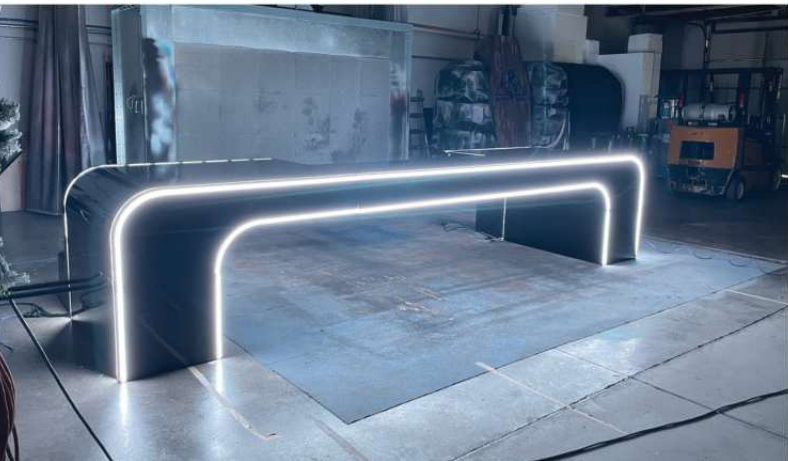

Event photography by Greg Fry

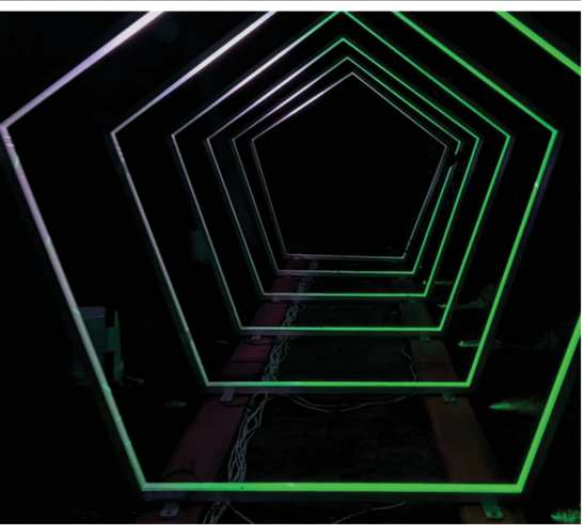



# PLINK INJECTOR

SKU: 73544 (12V-24V) / 73546 (5V)



The smartest way to connect and extend your pixel set-up, PLink injectors can be positioned as far as 300 metres from your Pixelator.

- > Works with the Pixelator series to extend pixel data over long distances
- > No configuration needed
- > Available in 5V & 12V-24V options
- > Requires external DC power supply
- > 10A maximum throughput



DATA/POWER IN



DATA/VOLTAGE OUT



SEE PAGES 6-7

Learn how you can use the PLink system in conjunction with the Pixelator series for efficient control of LED pixel lighting.



# IP PLINK INJECTOR

SKU: 73924 (IP66 PLINK INJECTOR)



With this waterproof pixel data injector, you can take your pixel strips outdoors and drive them like a pro in practically any conditions.

- > 'Outdoor' version of 73544/73546
- > Works with the Pixelator series to extend PLink data over long distances
- > Impact, corrosion and UV-resistant
- > Rated IP66



DATA/POWER IN



DATA/VOLTAGE OUT





# CCC4

SKU: 73927



ENTTEC's CCC4 is a 4-channel, auto-addressable constant current (CC) LED dimmer designed to dim compatible constant current fixtures up to 1A per channel at 12-24V by default, with up to 16-bit resolution (Choose from (RGB 8-Bit, RGBW 8-Bit, RGB 16-Bit or RGBW 16-Bit)). Robust and reliable, the CCC4 is the ultimate high-precision CC dimmer with PLink or DMX input, perfect for installations using high-power lights.



Talk to us about the CCC4's highly-customisable OEM options, tailored to meet specific project requirements.

- > DMX/PLink input + RDM-addressable
- > Auto-addressable through ENTTEC's PLink system for simple commissioning
- > 1A per channel
- > User serviceable 5A fuse
- > 4 operating modes using DIP switches
- > Converts PLink data from your Pixelator
- > Flicker-free 1KHz dimming

DATA/POWER IN

PLink
DMX
12-24v (4.5A)

DATA/VOLTAGE OUT

PLink
12-24 V



Integrated with the ENTTEC Pixelator system, the CCC4 is the perfect driver for architectural constant current flood or spotlight fixtures.



# CVC4

SKU: 73926



The CVC4 is an installation-grade constant voltage LED dimmer capable of dimming 4 x 5Amp outputs with up to 16-bit resolution (Choose from (RGB 8-Bit, RGBW 8-Bit, RGB 16-Bit or RGBW 16-Bit)). It can be addressed using RDM or ENTTEC's PLink protocol for quick, hassle-free commissioning. Requires an external DC power supply.



- > DMX/PLink input + RDM-addressable
- > Auto-addressable through ENTTEC's PLink system for simple commissioning
- > 5A per channel
- > User serviceable 20A fuse
- > 4 operating modes using DIP switches
- > Converts PLink data from your Pixelator
- > Flicker-free 1KHz dimming

### ENTTEC LED MAPPER (ELM) SOFTWARE

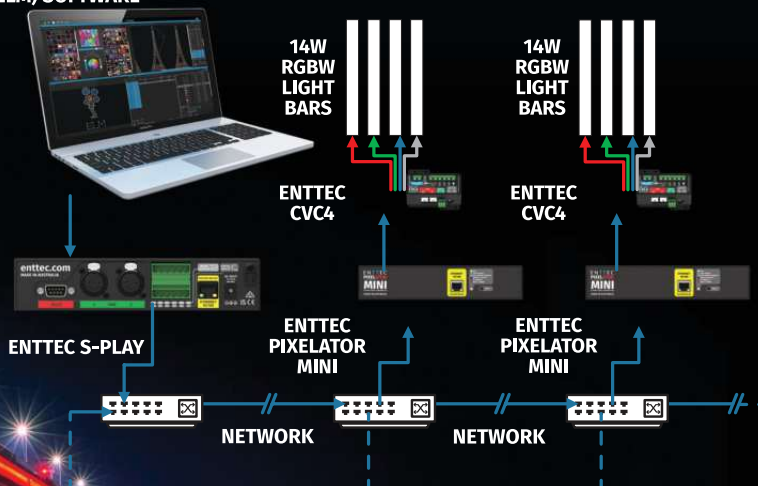

DATA/POWER IN

PLink
DMX
12-24V (20A)

DATA/VOLTAGE OUT

PLink
12-24V

## CVC4 @ WORK

200 x CVC4s driving RGBW LED bars to light up Hobart's Tasman Bridge. Lighting design by Decrolux, working closely with Industrial Fire & Electrical (IF&E) & Hobart City Council.



# CONSTANT VOLTAGE (CV) STRIPS

SKU: 73310 NA1 | 73310 NA2 | 73310 NA3 | 73310 NA4

Manufactured to suit any desired mood or effect, our Constant Voltage LED strips are available in 10m reels of white, tuneable white, RGBW and RGB varieties. CV strips are great for uniform designs or injecting creative flair into any project.

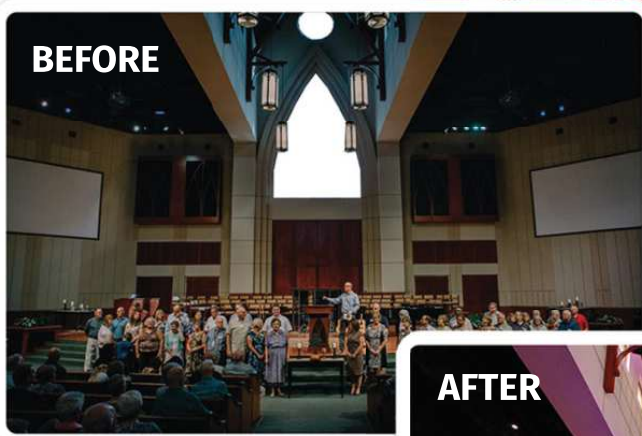

**BEFORE**

This spectacular transformation of Florida's Seven Rivers Church was undertaken by the team at Summit Integrated.

ENTTEC CV LED tape strips were used to create accents and wall washes that completely change the atmosphere of the space, lifting it to ethereal heights.



**AFTER**

- > 24V DC power
- > Easy to control
- > IP20 indoor use only
- > LEDs dimmable using the ENTTEC CVC4
- > Engineered and checked by our in-house team

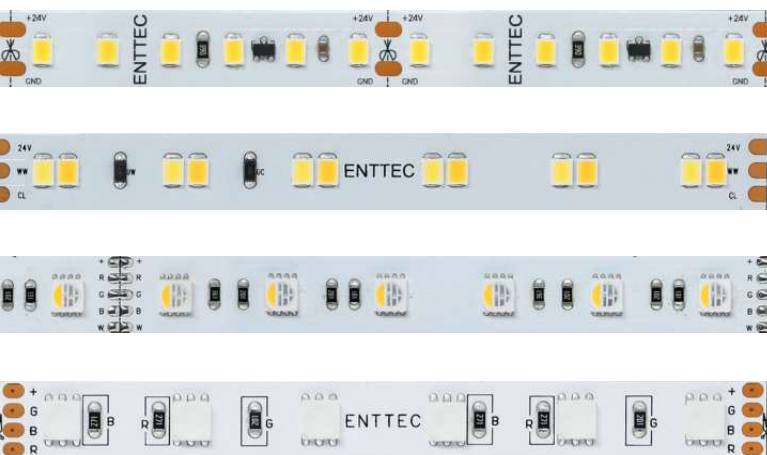

## CV LED strips

**WHITE NA1**  
6000K / 4000K / 3000K | 120 LEDs/m

**TUNEABLE WHITE NA2**  
3000K - 5500K | 120 LEDs/m

**RGBW NA3**  
RGBW 4000K | RGBW 1111 lm/m | 60 LEDs/m

**RGB NA4**  
611 lm/m | 60 LEDs/m





# D-SPLIT

SKU: 70578 (2 x 3-PIN + 2 x 5-PIN) / 70579 (4 x 5-PIN) / 70574 (4 x 3-PIN)

An optically-isolated DMX splitter and repeater for DMX512, the D-SPLIT gives you the ultimate flexibility to link up to 32 fixtures.

- > Three output configuration options
- > Each output can support a DMX chain of up to 32 fixtures
- > Compatible with any DMX controller
- > Run four different optically-isolated DMX branches
- > Protects against 1000V of stray voltage



DATA IN

DMX 7-24v

DATA OUT

DMX



70578 (2 x 3-PIN + 2 x 5-PIN)



70579 (4 x 5-PIN)



70574 (4 x 3-PIN)



# DIN RDS4

SKU: 72004

The latest revision to our 4-port DIN-rail DMX/RDM splitter: a high quality, installation grade device in a slimmer, more compact enclosure.

- > 1 DMX/RDM input + 4 DMX/RDM outputs
- > DMX512-A & ANSI E1.20 RDM support
- > Electrically-insulated case material
- > Surface or TS35 DIN rail mount
- > No configuration required
- > 1500V Opto-isolation between each DMX port



DATA IN

DMX RDM 7-24v

DATA OUT

DMX RDM



"We used the ENTTEC DMX USB PRO because of its compatibility with our main installation software. We've used this great little black box to power other Nike projects (and personal art projects). On this particular project, we controlled around 30 different custom LED fixtures with a bunch of them."

**Justin Gitlin (aka Cacheflowe)**  
Multimedia artist & software developer

3-storey tall multimedia sculpture for Nike's latest flagship retail hub in New York City, featuring multiple ENTTEC DMX USB PRO devices - by Cacheflowe / Hovercraft Studio

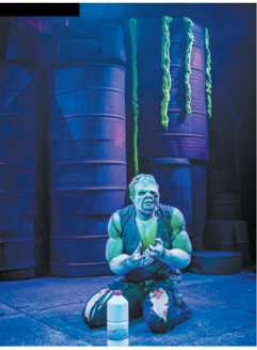
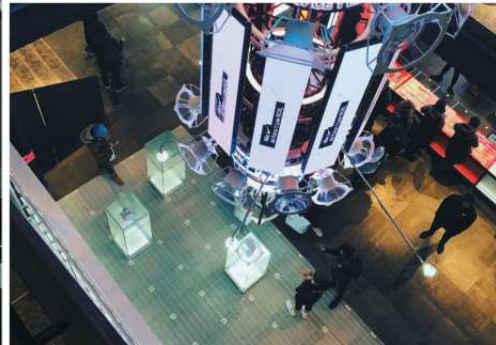
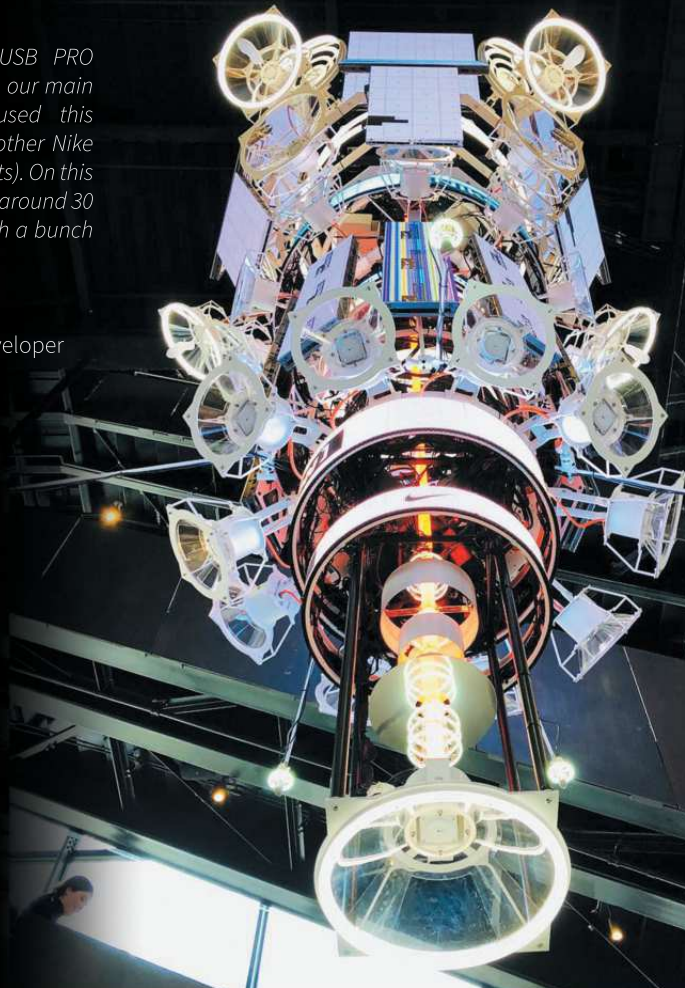

Pixelators / PLinks / ENTTEC pixel strips @ Toxic Avenger musical, London's West End - by White Light Ltd



# STORM10

SKU: 70056



A compact and powerful 10-port, multi-protocol Ethernet to DMX converter, the Storm10 has been engineered for the smooth distribution of DMX universes. And with a little bit of creative thinking, it can even control far more than just lighting fixtures!



Convenient and easy to use, DMX outputs using RJ45 connectors (ANSI 1.27) are universally familiar to installers and require no soldering.

- > Multi-protocol support
- > Control up to 10 DMX universes
- > Easily configured via web browser
- > PoE or 12-24vDC power input options
- > RDM capability
- > EN-Case modular housing for easy rack, surface or DIN-rail mounting

DATA IN



DATA OUT

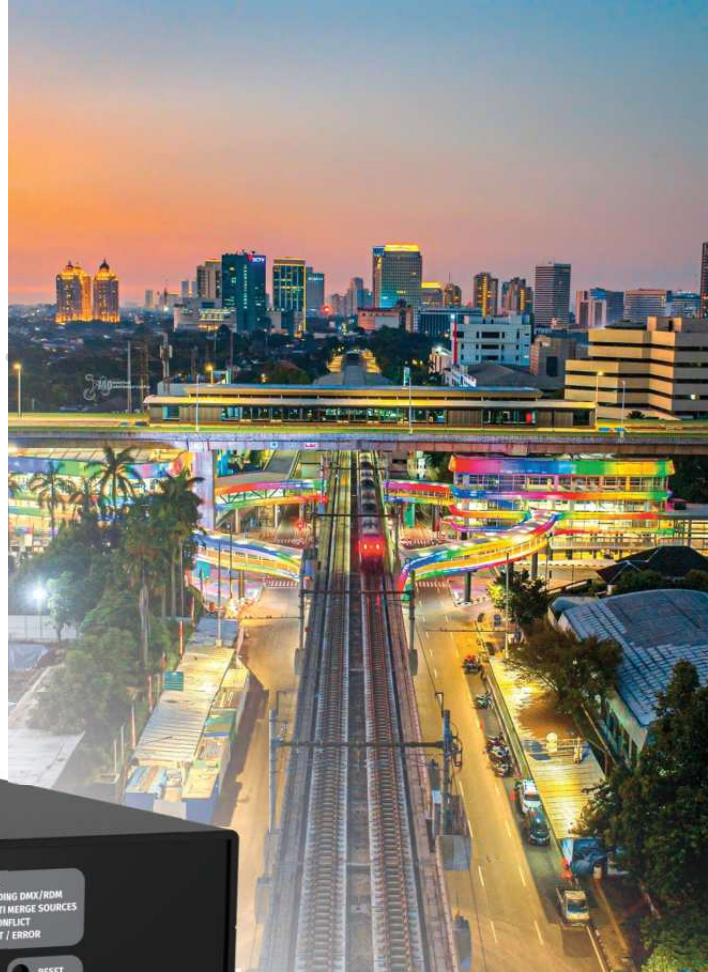

A series of ENTTEC STORMs played an integral role in conjunction with ENTTEC LED Mapper (ELM) and two ENTTEC S-PLAYs in the creation of this stunning circular LED skybridge installation at CSW-ASEAN TOD, Kebayoran Baru, South Jakarta, Indonesia. Has public transport ever looked as enticing as this before?

Project credit: PT Panasonic Gobel Eco Solutions Sales Indonesia, with lighting design and supply by PT Scienler Teknologi Indonesia.

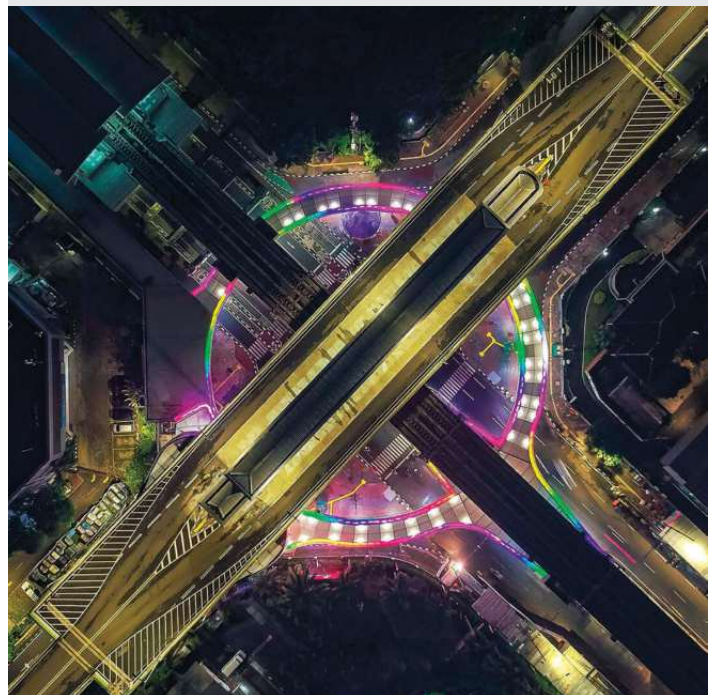



# DIN ETHERGATE MK2

SKU: 71031

With 2 Universes of bi-directional DMX to standard DMX512-A conversion and ArtRDM support, the DIN Ethergate Mk2 is a flexible, cost-effective method to connect physical DMX devices to your network infrastructure.



Unlock enhanced performance with Overdrive Mode\*; outputting at higher data transmission rate 500Kbps to control up to 1,024 channels per port (4 Universes in total).

\*Feature only works with DMX500K-compatible fixtures.

- > Two bi-directional DMX/ E1.20 RDM ports
- > Support for Art-Net 4, sACN, ESP & KiNet
- > HTP/LTP merging for DMX sources
- > Surface or TS35 DIN rail mount
- > Daisy-chain to expand your network
- > Intuitive configuration & web updates

#### DATA/POWER IN



#### DATA OUT





# ODE MK3

SKU: 70407



With 2 Universes of bi-directional Ethernet/DMX conversion and Art-RDM support, the ODE MK3 is the perfect all-rounder.

- > Two bi-directional DMX ports with optional RDM (E1.20) support
- > 10/100 Mbps Ethernet port with Power over Ethernet or DC 12-24V input
- > Support for Art-Net 4, sACN and ESP
- > Easy to use web-based interface
- > Configurable DMX output refresh rate

#### DATA/POWER IN



#### DATA OUT



## IMMERSIVE ART

German entrepreneur Lars Hinrichs gives a press conference to announce the launch of Europe's first Digital Art Museum in Hamburg.

Lighting designer Maximilian Dickhaus used ENTTEC LED Mapper (ELM) to control these LED pixel bars during the livestreamed presentation.

Discover what ELM can do for *your* projects on p.26 of this booklet.

"We have been using ENTTEC products for years and were looking for a solution that enabled us to address over 30,000 LEDs via Art-Net. The ENTTEC Storm was a perfect match in terms of performance and usability."

Stefan Kainbacher  
Designer @ Neon Golden



ENTTEC Storm @ Magenta Telekom T-Center, Vienna, Austria ~ by Stefan Kainbacher



ELM controlled bridge, museum & concert hall @ Krasnoyarsk, Russia ~ by Pitch LLC



Pixelators / PLink system @ The Royal Opera House, Copenhagen, Denmark ~ by Stig Debois

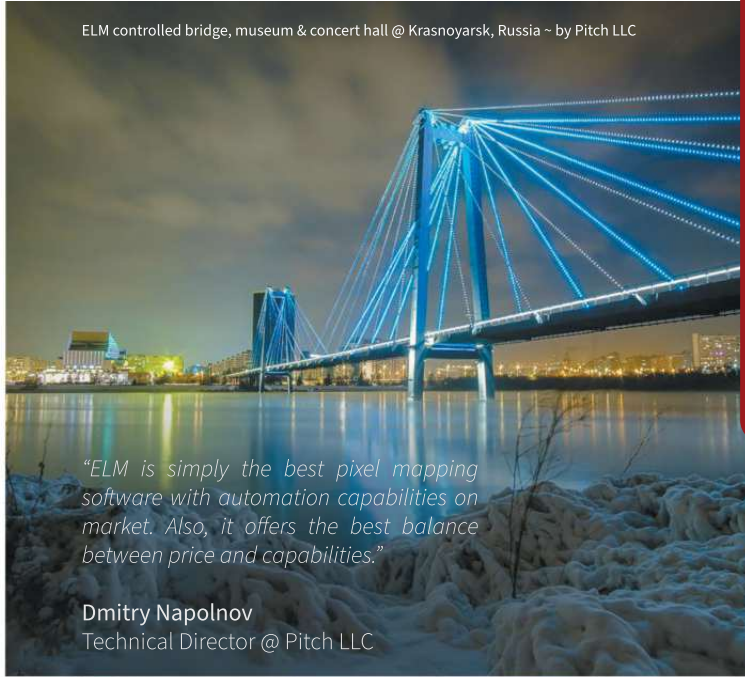

"ELM is simply the best pixel mapping software with automation capabilities on market. Also, it offers the best balance between price and capabilities."

Dmitry Napolnov  
Technical Director @ Pitch LLC



ELM & ENTTEC LED pixel strips @ Baroq House, Melbourne ~ by James Ady & Luke Stretton



ELM, Pixelator Mini, PLinks and LED strips @ Brisbane Powerhouse ~ by Nathen Street



# OPEN DMX USB

SKU: 70303

Compatible with a wide range of applications, get into the world of DMX control from your computer with this affordable interface.

- > Compact size
- > Standard 5-pin DMX port
- > Outputs up to 512 DMX channels
- > Powered by your computer's USB
- > Compatible with popular apps
- > Integrate into your own software using the openly available API to output DMX



DATA IN



DATA OUT



# DMX USB PRO

SKU: 70304

Lightweight, portable and truly professional, the DMX USB PRO is the industry standard to control lights from your computer.

- > USB 2.0 support with status LED
- > 1500V full isolation
- > RDM enabled + Input or Output mode
- > Internal frame buffer for stable DMX generation
- > Widely supported by a huge range of commercial and free software



DATA IN





DATA OUT



# DMX USB

## device comparison

<i>Features</i> ↓	OPEN DMX USB	DMX USB PRO
Part # (SKU)	70303	70304
Max Output Channels	512 Channels	512 Channels
DMX Out	Yes	Yes
DMX In	No	Yes
DMX Connector Type	5 pin DMX	5 pin DMX
Included Accessories	USB Cable	USB Cable
On-board Processing (timing and signal)	No. Dependent on the processing capabilities of your computer	Yes
Data & Power Line Isolation	No	1500V Isolation
Upgradeable Firmware	No	Yes
RDM Enabled	No	Yes. Requires firmware v2.4
User Configurable (via PRO-Manager) Refresh Rate (1 to 40 Hz) Break Time (96 uS to 1.3 mS) MaB (10.6 uS to 1.3 mS)	No	Yes
Ability to Manage, Test, & Update (via PRO-Manager)	No	Yes
Standalone Playback	No	No
Choose your own lighting software?	Yes	Yes
<i>Who is it for?</i> →	<ul style="list-style-type: none"> <li>&gt; Students</li> <li>&gt; Novice users</li> <li>&gt; Amateur productions</li> <li>&gt; Troubleshooters</li> </ul> 	<ul style="list-style-type: none"> <li>&gt; Community theatres</li> <li>&gt; Audiovisual productions</li> <li>&gt; Nightclubs</li> <li>&gt; Art installations</li> <li>&gt; Events</li> <li>&gt; Musicians</li> </ul> 

Pixelators, PLink system & ELM @ Glastonbury Festival ~ by Bailes + Light with ON LX

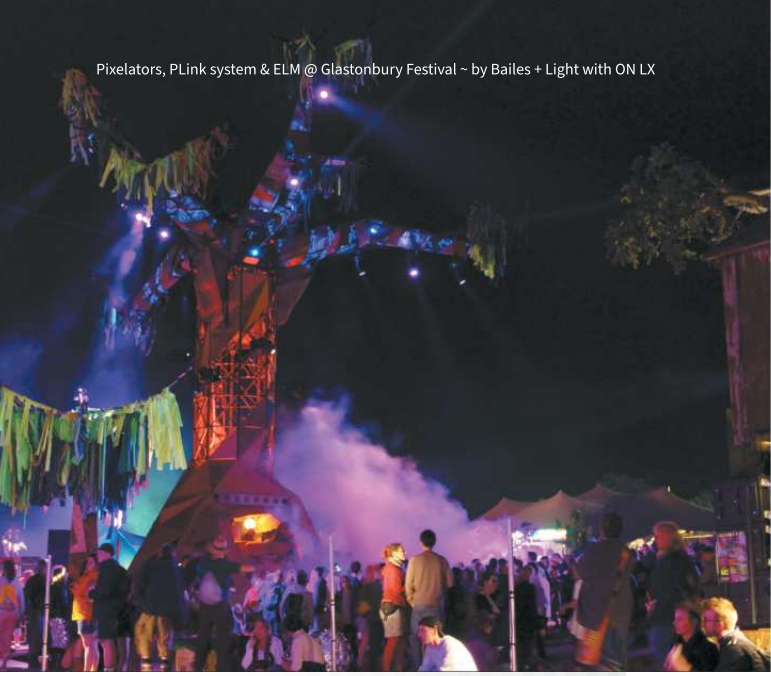

Pixelator Minis / PLink system @ Electric Picnic Festival, Ireland ~ by Luke Maguire



ELM @ Electric Daisy Carnival, Las Vegas ~ by KrohTech



ENTTEC pixel dots / PLink system / Pixelator Mini @ Australian Open, Melbourne ~ by Landor / The P.A. People



Pixelator / PLink system @ We Are FSTVL Festival ~ by This is Loop

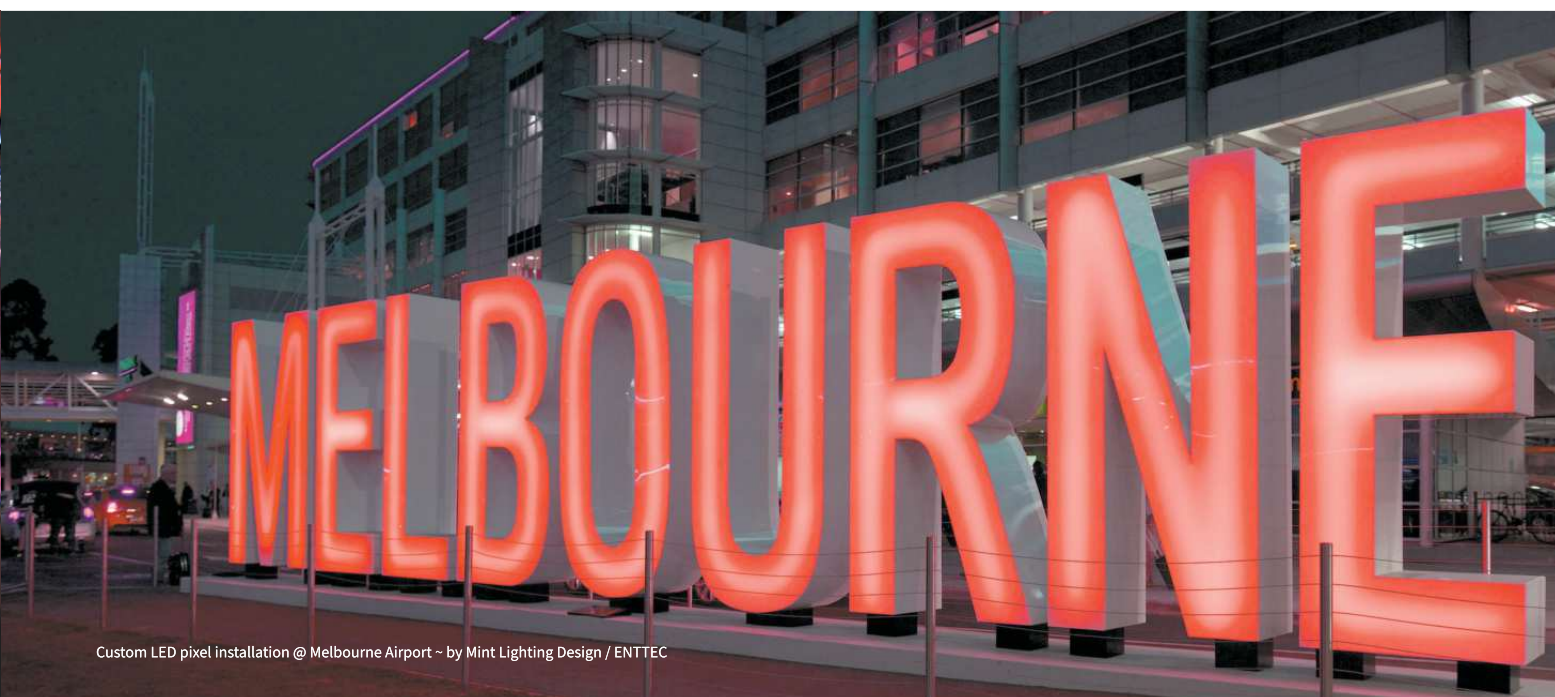

Custom LED pixel installation @ Melbourne Airport ~ by Mint Lighting Design / ENTTEC



## Next-Gen DMX lighting control for DJs + live musicians.

ENTTEC, have worked alongside top musicians and audio engineers to bring you this state-of-the-art software designed to take your live performances to a new level.

By combining sound with light, you'll be able to create a fully-immersive experience for your audience and stay ahead of the competition ... without having to employ a lighting operator. It'll change the way your audience sees you forever.

Even with no previous stage lighting experience, EMU is easy to use and will quickly give you the power to create outstanding atmospheres and visual effects to enhance your music — from classic DMX looks to pixel-driven visuals — letting you focus on what you do best: hitting the right notes and putting on a good show!



SKU: 70680

### VST3/AU PLUGIN

Works with:

**Ableton Live**  
**Logic Pro**

**CUBASE** FL STUDIO  
+ more

EMU offers a Windows 32-bit or macOS 64-bit VST plugin capable of syncing the master playback state from your favourite DAW with the main EMU application, controlling program and bank changes directly from your DAW — ideal for tightly-timed cues, pixel effects and beat-perfect changes.

### REACTION TO LIVE AUDIO

EMU's Sound Tracker functionality allows you to set your lights to react directly to live audio in certain programs by taking an audio input from a soundcard, microphone or virtual loopback adapter: perfect for accenting drops, transitions, and even driving parameters inside dynamic pixel scenes.

EMU is a state-of-the-art, intuitive software package designed for live musicians to run automated or responsive light shows: now with visual LED mapping for pixel-based fixtures and creative effects.

- > Modern UI design: easy to learn, simple to use
- > Tempo-based to sync with your music
- > Visual attribute manager for fast show programming
- > LED mapping with individual pixel control (up to 8U)
- > Outputs 1 DMX universe (512 channels) via 3-pin or 5-pin XLR ports, or up to 8 universes (4096 channels) of Art-Net via Ethernet port
- > Control any DMX512 fixture: cloud-based database
- > VST plugin to control EMU from a DAW
- > Flexible licencing options

#### DATA IN



#### DATA OUT



#### PLATFORMS



**SYSTEM REQUIREMENTS:** Mac: macOS 14 Sonoma or later, dual-core 2 GHz processor or better, 8GB memory, graphics card with 4GB VRAM or better. Windows: Supports 64-bit variants of Windows 10/11, dual-core 2 GHz processor or better, 8GB memory, graphics card with 4GB VRAM or better.



features

Mixing desk-style interface

Designed with live performances in mind, EMU's hardware-style user interface is quick to learn and easy to use. EMU's intuitive, tempo-based approach allows for the synchronisation of lighting and music with oscillators in real time.

With features such as lock, invert, duplicate and a visual attribute selector along with a number of handy keyboard shortcuts, building your show is a breeze. Create static looks, dynamic chases & moving effects using virtual sliders to control each light's parameters, or design pixel-based scenes visually by arranging fixtures on-screen like a stage canvas.

Thanks to its 'bank and program'-based logic to store each look, EMU makes it familiar and easy for musicians to enter the world of lighting control without a steep learning curve.



MIDI integration

EMU's MIDI learn functionality allows controls to be mapped to physical MIDI control hardware or software applications with the use of a virtual MIDI loopback adaptor. When EMU has been linked to a MIDI input, toggling between the previous / next program or bank with external software is easy.

For users that want more direct control over every attribute in their show, EMU allows individual faders to be mapped to MIDI to control their level in real time for precise detail, including hands-on control of effect intensity, speed and other performance parameters.

For those taking advantage of EMU's inbuilt oscillators, tap tempo can be set through MIDI CC or a MIDI clock signal can be used to set the global speed to synchronise all show file oscillators in real time.

What else do I need?

You'll need a USB -> DMX interface or Art-Net node to connect lights to your computer. For the ultimate EMU experience, choose the official EMU Hardware interface (see overleaf), giving you footswitch and MIDI connectivity and the ability to output a multi-universe display.

CONTROL ANY DMX-512 FIXTURE

Whether you want to control LED washes, moving heads, dimmer packs, smoke machines, scanners, moonflowers ... you name it, you can control them using EMU's DMX or Art-Net output, including compatible pixel strips, panels and other addressable LED fixtures via LED mapping.

ENTTEC has partnered with Crescit to give EMU a leading fixture library that receives

regular updates. Crescit is a company with a background in developing software to help professional lighting designers research, compile, manage and share production information and endeavours to add all known fixtures to their database.

With Crescit's vast fixture library integrated into EMU, this makes laboriously creating custom fixture profiles to control your equipment a thing of the past.





# EMU HARDWARE

SKU: 70056

Designed with live musicians and touring performers in mind, this compact interface works seamlessly with EMU Software to run automated and audio-responsive light shows. With customisable MIDI/footswitch integration, EMU hardware provides hands-free, real-time control adjustable to any performance needs.

Purchase **emu** hardware to receive a **FREE** one-year **emu** Premium software subscription followed by a lifetime 30% discount subscription voucher!



- > Handy USB Type-C power/data port
- > Supports 512 channels through 3-pin and 5-pin XLR connectors
- > Ethernet port for Multi-Universe control using ENTTEC devices
- > Footswitch/MIDI TRS port for direct control during performances

Use either the 5 or 3-pin XLR port to control up to 1 Universe of DMX (512 control channels). Or, to put on a bigger show, there's an Ethernet port through which Premium subscribers are able to control up to 8 Universes (4,096 control channels) using compatible controllers (Art-Net to DMX/SPI).



#### DATA/POWER IN



#### DATA OUT



# ENTTEC LED lighting control video tutorials



*"Just wanted to say thanks for all your videos - they are really appreciated. I've basically just binge watched the whole playlist and must admit I knew a lot of it, but it's good to remind oneself of all the points as well as pick up one or two new tips!"*

**Francois Ashton**  
Lighting designer

Join the expert ENTTEC team as they guide you through exactly what you need to know about lighting control and how to do it.

If you've ever wanted to learn the secret tips and tricks that professional lighting designers or installers use, simply head to our YouTube channel and watch along as our experts take you through a variety of amazing devices as well as handy topics such as soldering, voltages, power supplies, fuses, software protocols and much more.

There's something for everyone, no matter what level of experience you have!



Watch now @  [YouTube.com / ENTTECOfficial](https://www.youtube.com/ENTTECOfficial)

This brochure is intended as an introductory guide to a number of core products from our constantly-evolving range.

Just as new products may become available and therefore not yet feature in this brochure, availability of existing products is also subject to change at any time, so please visit our website for the latest information.

Also, don't hesitate to contact us directly or ask your local dealer if you have any questions or require detailed technical specifications for any of the products featured within.

V1.0 © ENTTEC 2026. While all reasonable care has been taken to ensure that the information presented within this publication is accurate as of the time of printing, it is intended as a guide only and ENTTEC shall not be held liable for any errors or omissions.

**enttec.com**  
MELBOURNE AUS / LONDON UK / RALEIGH-DURHAM USA / DUBAI UAE / GUANGZHOU CHINA